

Instruction manual SMART

Laboratory incubators

models: CLN 15, CLN 32, CLN 53, CLN 115, CLN 180, CLN 240
CLW 15, CLW 32, CLW 53, CLW 115, CLW 180, CLW 240, CLW 400,
CLW 750, CLW 1000

Drying ovens

models: SLN 15, SLN 32, SLN 53, SLN 75, SLN 115, SLN 180, SLN 240
SLW 15, SLW 32, SLW 53, SLW 75, SLW 115, SLW 180, SLW 240,
SLW 400, SLW 750, SLW 1000

Drying ovens with nitrogen blow

models: SLWN1 15, SLWN1 32, SLWN1 53, SLWN1 115, SLWN1 240
SLWN2 15, SLWN2 32, SLWN2 53, SLWN2 115, SLWN2 240

Laboratory sterilizers

models: SRN 53, SRN 115, SRN 240
SRW 53, SRW 115, SRW 240, SRW 400, SRW 750, SRW 1000

Pass-through sterilizers

models: SRWP 115, SRWP 240

Before using the equipment, please read carefully this instruction manual!

Version 1.31

Issued 3.11.2023



Manufacturer's address:

POL-EKO A.Polok-Kowalska sp.k.

ul. Kokoszycka 172 C

44-300 Wodzisław Śląski

Country of origin: Polska

As a manufacturer, we inform you that we took the necessary measures to ensure that this device fully meets your expectations and is reliable for a long period of use. Due to the continuous improvement of our products, as well as the expansion of our offer, any suggestions regarding additional functions and equipment functioning are welcome. Visit our homepage www.pol-eko.com.pl/home-en/

Equipment disposal













This equipment is marked with the crossed out wheeled bin symbol to indicate that this equipment must not be disposed of with unsorted waste. Instead it's your responsibility to correctly dispose of your equipment at lifecycle -end by handling it over to an authorized facility for separate collection and recycling. It's also your responsibility to decontaminate the equipment in case of biological, chemical and/or radiological contamination, so as to protect from health hazards the persons involved in the disposal and recycling of the equipment. For more information about where you can drop off your waste of equipment, please contact your local dealer from whom you originally purchased this equipment.

By doing so, you will help to conserve natural and environmental resources and you will ensure that your equipment is recycled in a manner that protects human health.

Thank you!

Contents

1.	INTENDED USE AND IMPORTANT INFORMATION FOR THE USER	6
2.	PACKAGE CONTENTS	7
3.	BEFORE THE FIRST USE	8
3.1.	Installation of shelves	10
3.2.	Remarks on the placement of samples.....	10
3.3.	Closing chamber door.....	11
4.	DESCRIPTION OF THE DEVICE	11
4.1.	Design of CL, SL, SR, SRWP devices	11
4.2.	Design of SRWP devices.....	14
5.	DEVICE EQUIPMENT (standard and optional)	16
5.1.	External door with viewing window (optionally for CL, SL, SR).....	16
5.2.	Internal glass door (standard for CL)	16
5.3.	HEPA filter (optionally for all units)	16
5.4.	Internal socket (optionally for CL)	17
5.5.	Door lock (standard for all units)	17
5.6.	Access port for external sensor (standard for all units).....	18
5.7.	Open door alarm (standard for all units)	18
5.8.	Internal light (optionally for all units)	18
5.9.	USB port (standard for all units).....	19
5.10.	Display battery backup (optionally for CL, SL, SLWN, SR, SRWP).....	19
5.11.	Consumables.....	20
6.	DEVICE OPERATION	20
6.1.	External memory (USB flash drive).....	20
6.2.	First boot.....	21
6.3.	 Main screen.....	21
6.3.1.	Information panel.....	22
6.3.2.	The meaning of icons and symbols	25
6.3.3.	Upper expandable and configurable menu.....	27
6.3.4.	Alarm bar.....	28
6.4.	Quick Program.....	28
6.5.	 Programs.....	30
6.5.1.	Creating / editing a program	31
6.5.2.	Segments edition.....	32
6.5.3.	Protection class	36
6.5.4.	Temperature protection class 3.1 (optionally).....	36
6.5.5.	Priority	36
6.5.6.	Loop	37
6.5.7.	SR and SRWP devices – factory predefined sterilization programs	37
6.6.	Starting the program	37
6.6.1.	The first way	37
6.6.2.	The second way	39

6.7.	Quick Change of parameters	40
6.7.1.	Quick change of set temperature	40
6.7.2.	Quick change of set time	41
6.7.3.	Quick change of fan efficiency and degree of air-flap opening	42
6.8.	 Statistics	42
6.9.	 Data record.....	43
6.10.	 Event log	45
6.11.	 Info	47
6.12.	 User settings panel.....	47
6.12.1.	Unlocking the touch screen	48
6.13.	 Time	49
6.14.	 Alarms	50
6.14.1.	Alarms when set parameters are exceeded	50
6.14.2.	Open door alarm	51
6.14.3.	STM function	52
6.14.4.	Mute option.....	54
6.15.	 Network	54
6.16.	 Corrections.....	55
7.	INTERFACE.....	56
7.1.	MODBUS TCP.....	56
8.	TEMPERATURE PROTECTION.....	56
8.1.	Temperature protection class in CL, SL, SR, SRWP models	57
9.	SLWN DRYING OVENS WITH NITROGEN BLOW.....	57
9.1.	Description of the kit	58
9.2.	Connection.....	60
9.2.1.	Connection of the Kit A.....	60
9.2.2.	Connection of the Kit B.....	61
9.2.3.	Connection of the Kit C.....	62
9.3.	Shut-off solenoid valve for gas supply (optionally).....	63
9.4.	Operation and maintenance of the dry nitrogen blow system	63
9.5.	Methodology for calculating the nitrogen flow rate in the drying oven.....	64
10.	SRWP pass-through sterilizers	66
10.1.	Precautions.....	66
10.2.	Package contents	66
10.3.	Preparing the aperture in the wall	66
10.4.	Installation of SRWP sterilizer.....	67
11.	CONNECTING THE DEVICE TO A COMPUTER.....	69

12. CLEANING AND MAINTENANCE OF THE DEVICE	69
12.1. Exterior cleaning	70
12.2. Interior cleaning	70
12.3. Cleaning the touch screen	71
13. ADVICE ON HOW TO SAFELY STORE THE DEVICE.....	72
14. TROUBLESHOOTING	72
14.1. Possible defects.....	72
15. WARRANTY CONDITIONS	73
16. RATING PLATE.....	74
17. TECHNICAL DATA.....	75
17.1. CL, SL, SLWN*, SR, SRWP** devices	75
18. DECLARATIONs OF CONFORMITY	77

1. INTENDED USE AND IMPORTANT INFORMATION FOR THE USER

CL laboratory incubators, SL drying ovens, SR laboratory sterilizers are laboratory devices designed for incubation, drying and sterilization with hot air of samples at following temperature ranges:

- laboratory incubators CL: 5°C above ambient temperature ... +100°C
- drying ovens SL: 5°C above ambient temperature ... +300°C
- laboratory sterilizers SR: 5°C above ambient temperature ... +250°C
- pass-through laboratory sterilizers SRWP: 5°C above ambient temperature ... +250°C
- SLWN drying ovens with nitrogen or other inert gas blow (with a dozen exchanges per hour): 5°C above ambient temperature ... +250°C. When used as a standard drying oven, the temperature range is: 5°C above ambient temperature ... +300°C

Laboratory incubators, drying ovens and laboratory sterilizers have an electric heating system. All devices are controlled by a precise SMART controller, thanks to which the set temperature is maintained with good fluctuation and variation. The devices are available in the following versions:

- with natural (N) air convection: models CLN, SLN, SRN
- forced (W) air convection: models CLW, SLW, SLWN, SRW (in the chamber there is one or more fans, depending on unit's capacity, which force air movement – for devices with forced air circulation, the symbol



appears on the screen.

Drying ovens with nitrogen flow, SLWN1 and SLWN2 models are used, among others, for the determination of total moisture in hard coal according to the **PN-ISO 589:2006** norm which requires that coal samples susceptible to oxidation should be dried at a temperature of + 105°C in a drying oven with a nitrogen flow.

Requirements for the use of the equipment are given in point 6 of the norm. A drying oven with nitrogen flow should be used to control the temperature in the range of + 105°C to + 110°C with the additional possibility of blowing with a stream of dry nitrogen at a flow rate of about 15 volumes of the drying oven per hour. For detailed information on the available models and equipment, see [Section 9](#).

The meaning of information symbols

	This symbol means that failure to follow the instructions could endanger people's health or life, or damage the device. The manufacturer is not liable for damages resulting from non-compliance with the instructions contained in the manual.
	Applies to SL and SR: when operating at high temperatures (over 200°C), the door and the unit housing may be hot.
	This symbol indicates helpful tips.

To guarantee your security and the longevity of the unit, please comply with the following rules:

1.	<u>The unit cannot be installed:</u> <ul style="list-style-type: none"> • outside, • in damp places or places which can be easily flooded, • near flammable or volatile substances, • near acids or in corrosive environments.
2.	<u>It is forbidden to:</u> <ul style="list-style-type: none"> • store inflammable or volatile substances inside the unit – equipment is not made in an explosion-proof version, • touch live parts of the unit, • operate the unit with wet hands,

Instruction manual CL, SL, SLWN, SR, SRWP SMART

	<ul style="list-style-type: none"> • put water vessels on the unit, • climb on the unit, • overload the shelves (the maximum load is described in technical data), • place objects on the bottom of the chamber.
3.	<p><u>You should:</u></p> <ul style="list-style-type: none"> • place samples in such a way to provide proper air circulation in the chamber, • open the door for the shortest period of time to reduce temperature fluctuations, • secure samples from being blown out by the chamber fan e.g powdery samples, • always check that the doors are closed correctly, • use only mains with earth to avoid electric shocks, • unplug the power cable holding the protective cover and not the cable itself, • disconnect the unit from the mains before undertaking any repairs or maintenance work (in order to not lose the warranty during its duration, all repairs should be carried out by an authorized service), • protect the power cable and the plug from any damage, • disconnect the power plug before moving the unit, • disconnect the power plug if the device will not be used for a long period of time, • disconnect the unit and protect it from reconnecting if it has any visual fault.

	<p>The manufacturer is not responsible for corrosion, damage to electronics or other elements of the equipment caused by placing inside substances that have an adverse effect on the materials from which it was made.</p>
---	--

Failure to comply with the above recommendations may result in damage to the device or deterioration of technical parameters, as well as loss of warranty.

2. PACKAGE CONTENTS

Drying ovens (SL) and laboratory incubators (CL) in SMART version are delivered with:

Device	SL/CL									
Capacity	15	32	53	75	115	180	240	400	750	1000
Shelves [pcs.]	1	1	2	2	2	3	3	3	5	6
Slides [pcs.]	2	2	4	4	4	6	6	6	10	12
Power cord [pcs.]	1	1	1	1	1	1	1	1	1	1
								SL - INTEGRATED		
Rubber cap [pcs.]	x	x	1	1	1	1	1	1	1	1
Key for door lock [pcs.]	2	2	2	2	2	2	2	2	2	2
Wrench (13mm) for wheels adjustment [pcs.]	x	x	x	x	x	x	x	1	1	1
Quality Control Certificate [pcs.]	1	1	1	1	1	1	1	1	1	1

Laboratory sterilizers (SR) in SMART version are delivered with:

Device	SR					
Capacity	53	115	240	400	750	1000
Shelves [pcs.]	2	2	3	3	5	6
Slides [pcs.]	4	4	6	6	10	12
Power cord [pcs.]	1	1	1	1	1	1
Rubber cap [pcs.]	1	1	1	1	1	1
Key for door lock [pcs.]	2	2	2	2	2	2
Wrench (13mm) for wheels adjustment [pcs.]	x	x	x	1	1	1

Quality Control Certificate [pcs.]	1	1	1	1	1	1
------------------------------------	---	---	---	---	---	---

Pass-through sterilizers (SRWP) in SMART version are delivered with:

Device	SRWP	
	115	240
Capacity		
Shelves [pcs.]	2	3
Slides [pcs.]	4	6
Power cord [pcs.]	1	1
Rubber cap [pcs.]	1	1
Key for door lock [pcs.]	4	4
Stand	1	1
Masking element	2	2
Quality Control Certificate [pcs.]	1	1

3. BEFORE THE FIRST USE

The manufacturer sends the device protected by cardboard profiles and foil. The device should be transported in **an upright position** and the package should be secured against sliding during transport.

	After receiving the device, visually assess its condition and equipment in the presence of the person delivering the goods. A courier company is responsible for any damage caused during transport.
---	---

	After transporting the device at a temperature below 10°C, wait at least 2 hours before connecting it to the mains.
---	--

On the surface of unit's components made of stainless steel, slight discoloration may occur. It is a result of the technologies used in the production of metal sheet in accordance with the requirements of PN-EN 10088-2 standard and it is not a defect of the unit.

	In SL drying ovens, SR sterilizers and CL laboratory incubators there's a ventilation air-flap at the back of the device. Hot air comes out of the air-flap during operation of the device. The manufacturer recommends using a non-flammable insulation screen on the wall or increasing the distance from the wall. Failure to do so may result in permanent damage to the wall, and in extreme cases even a fire.
---	---

	Applies to drying ovens (SL, SLWN) and sterilizers (SR, SRWP). Before first boot, it is recommended to turn on the device for 3 hours at the set temperature of 250°C. There might be a specific smell coming out from the interior of the chamber and this is not a malfunction.
---	--

The place of installation of the unit should meet the following conditions:

- ambient temperature +10°C...+28°C,
- recommended relative humidity of the ambient air up to 60%,
- the unit has not been designed to work in highly dusty environments,
- ensure proper ventilation in the room,
- the device should be placed on a hard and stable surface,
- the unit should be placed at least 100mm away from the walls,
- the height of the room must be at least 300mm greater than the height of the unit,
- the unit is not designed to be built-in,

Instruction manual CL, SL, SLWN, SR, SRWP SMART

- the place of installation of the device should be equipped with a socket with parameters suitable for the device.

If you don't comply with the above recommendations, the unit may get broken or it may worsen the technical parameters such as:

- temperature fluctuation,
- temperature variation,
- power consumption

and may result in loss of warranty.

Wheels / leveling feet

	<p>If the device has been equipped with wheels or leveling feet:</p> <ul style="list-style-type: none">• in the case of wheels after placing the unit at its destination, secure the device against movement by locking the wheels• in the case of feet, after placing the device in the destination, they should be leveled.
---	--

If the device is equipped with wheels, they must be locked and leveled. For this purpose use the red knob mounted in the wheel housing. At the beginning, the knob can be turned by hand, if it encounters resistance, use a 13 size wrench.

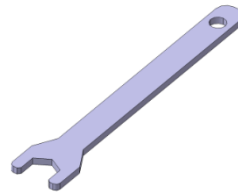

	<p>Leveling wheels are ONLY for positioning the device at its destination. They can not be used to transport the device!</p>
---	---

If the device is to be placed on a table (option) or base (option) which is equipped with the wheels with a lock, the wheels MUST be locked after placing the table / base in its final destination.

Electric installation

	<p>Power supply of the equipment is indicated on a rating plate on the unit. Connect the device to a socket with ground in order to avoid electric shocks in case of the unit's failure.</p>
---	---

The installation should be protected by a 16A slow-blow fuse and equipped with a residual current device.

3.1. Installation of shelves

To install the shelf or to change its position, follow these steps:

Install the shelf slide at the selected height by inserting it into perforations on the wall of the device. Do the same with the slide on the opposite wall.



Slide the shelf into the installed shelf slides. Now, the shelf is correctly installed!



To remove a shelf, perform the above steps in reverse order.

3.2. Remarks on the placement of samples

To provide proper air circulation and stable conditions in which the samples are stored in the chamber, it is necessary to keep the following rules:

- the max height of the samples should not exceed 1/3 of the space between the shelves,
- approx. 1/3 of the width and depth of the shelf should remain empty, while the distances between the samples, as well as between the samples and the wall should be approximately equal.

The picture below is an example of the placement of samples in the chamber.

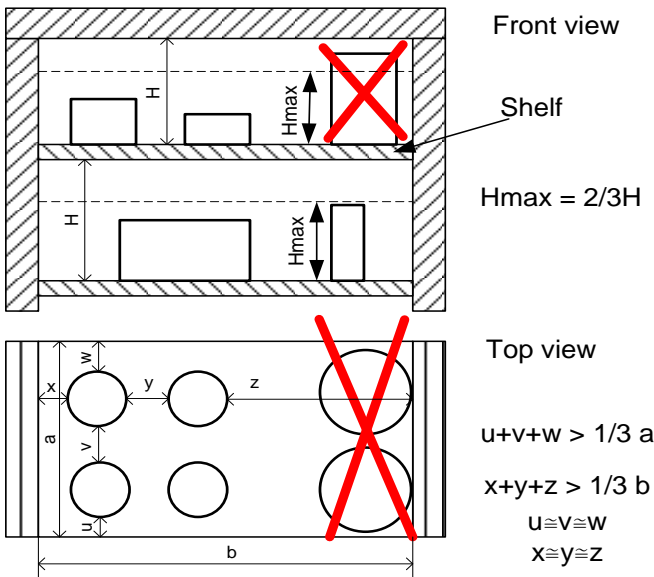

Following the above rules will provide best optimal parameters of temperature fluctuation and variation.

3.3. Closing chamber door

The external solid door of the units CL, SL and SR have two-point lock and open door sensor. If the door has not been closed properly, audible alarm will sound. You can set delay door alarm by: 30s, 1 min, 2 min, 5 min or 10 min ([see Section 6.14](#)).

4. DESCRIPTION OF THE DEVICE

SMART models are equipped with a PID microprocessor temperature controller and a 4.3 inch color touch screen with a resolution of 800x480.

4.1. Design of CL, SL, SR, SRWP devices

Below there's a picture showing CL, SL, SR, SRWP type devices (exemplary picture) with a description of the important components of the device.

The elements of the device are shown on the basis of a CLN 53.

Front view

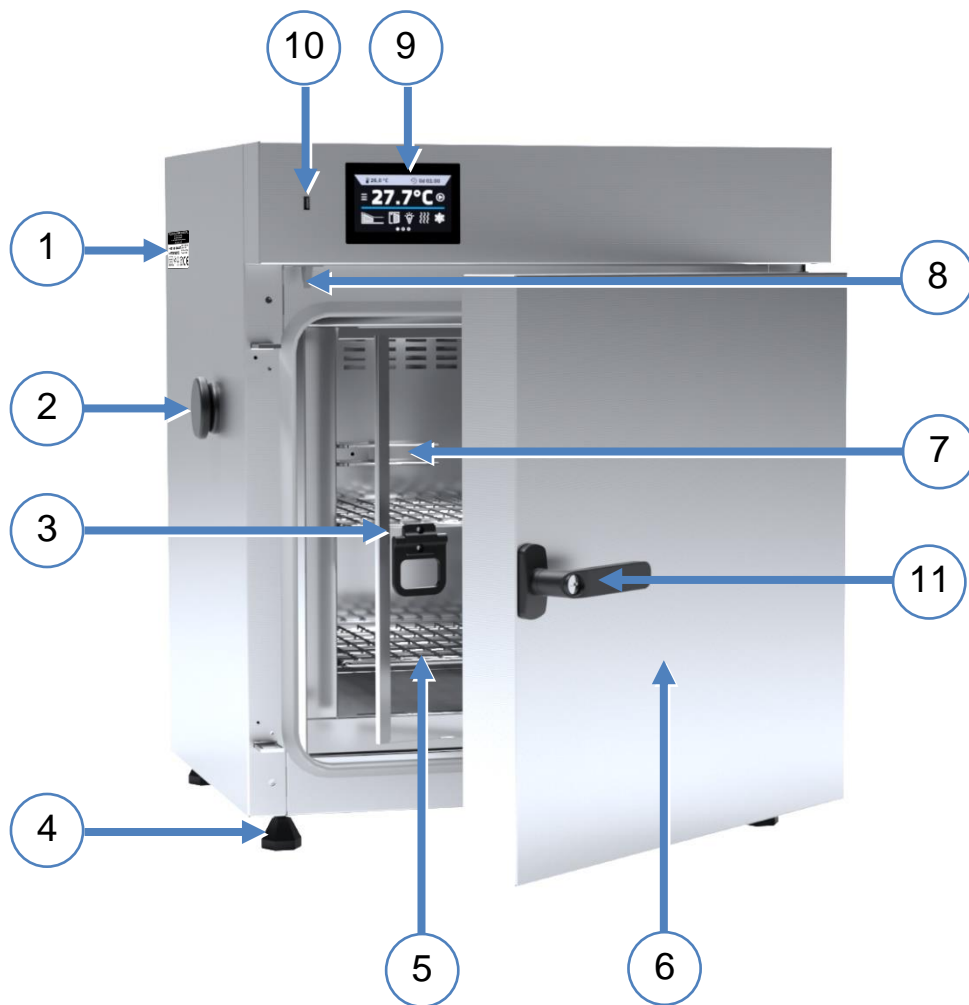

- 1) rating plate
- 2) access port \varnothing 30mm for external sensor
- 3) internal glass door (for CL)
- 4) adjustable feet
- 5) shelf
- 6) external solid door
- 7) temperature sensors
- 8) open door sensor
- 9) touch control panel
- 10) USB port
- 11) handle with key lock

Rear view

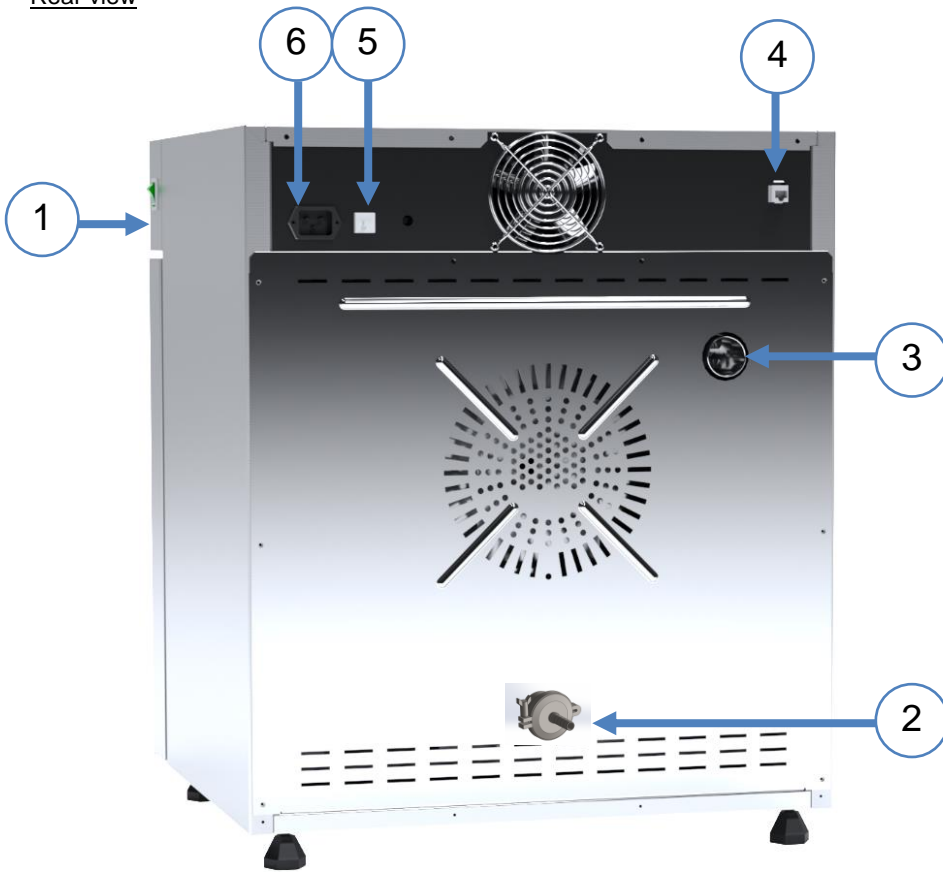

- 1) main switch
- 2) connector for connecting a hose with nitrogen (only for SLWN models)
- 3) air-flap
- 4) LAN port
- 5) fuse
- 6) main power socket C20

4.2. Design of SRWP devices

Below there's a picture of pass-through sterilizer (exemplary photo) with a description of the important components of the device.

Front view

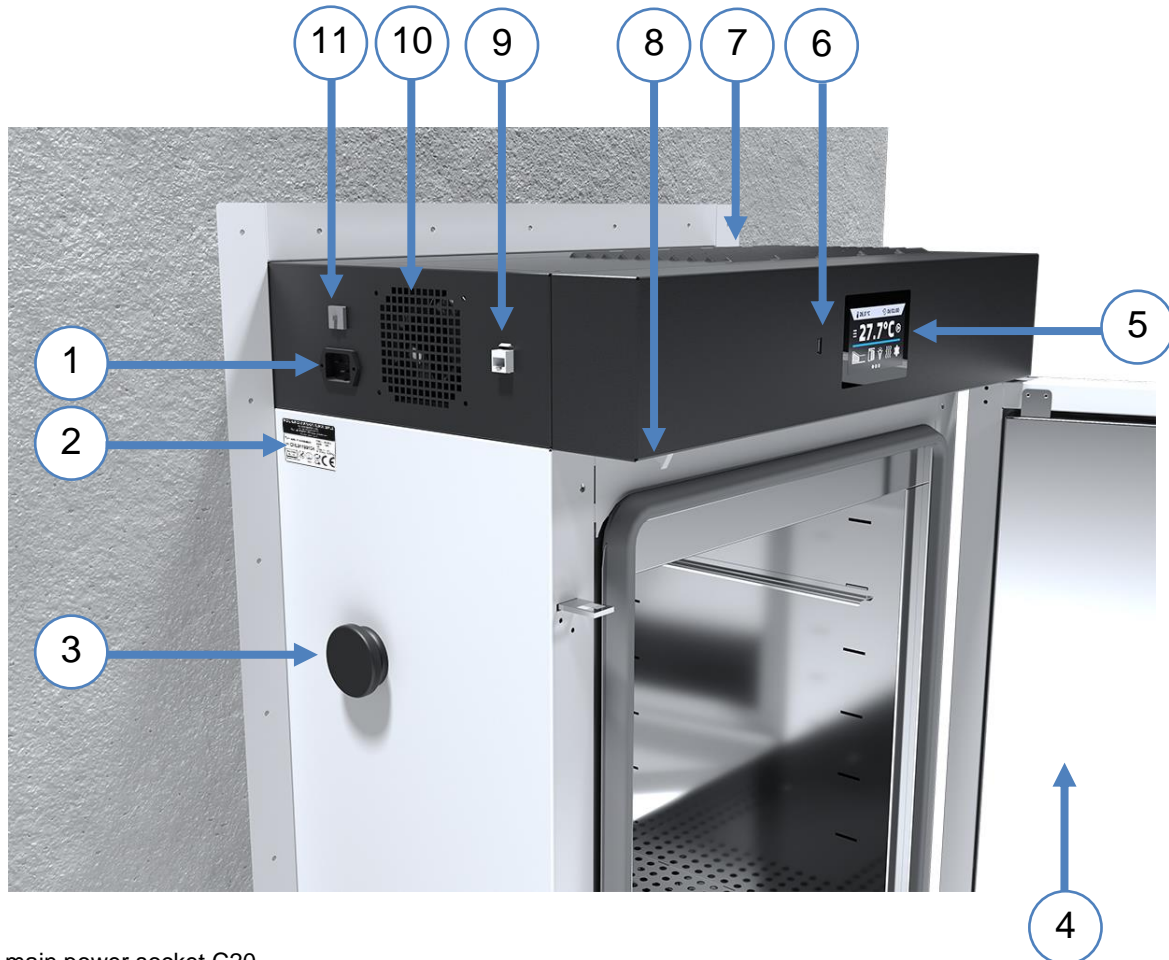

- 1) main power socket C20
- 2) rating plate
- 3) access port \varnothing 30mm for external sensor
- 4) external solid door with handle with a key lock
- 5) touch control panel
- 6) USB port
- 7) ventilation grille
- 8) open door sensor
- 9) fuse
- 10) electronics cooling fan
- 11) LAN port

Side view

- 1) main switch

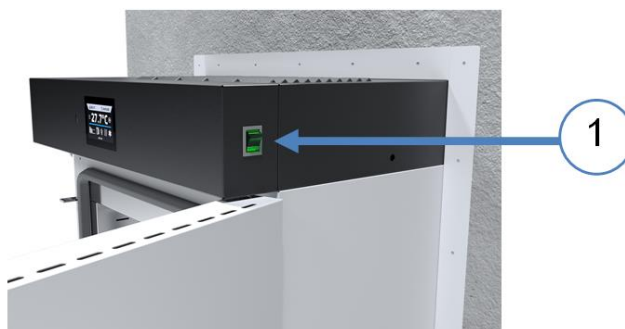

Rear view

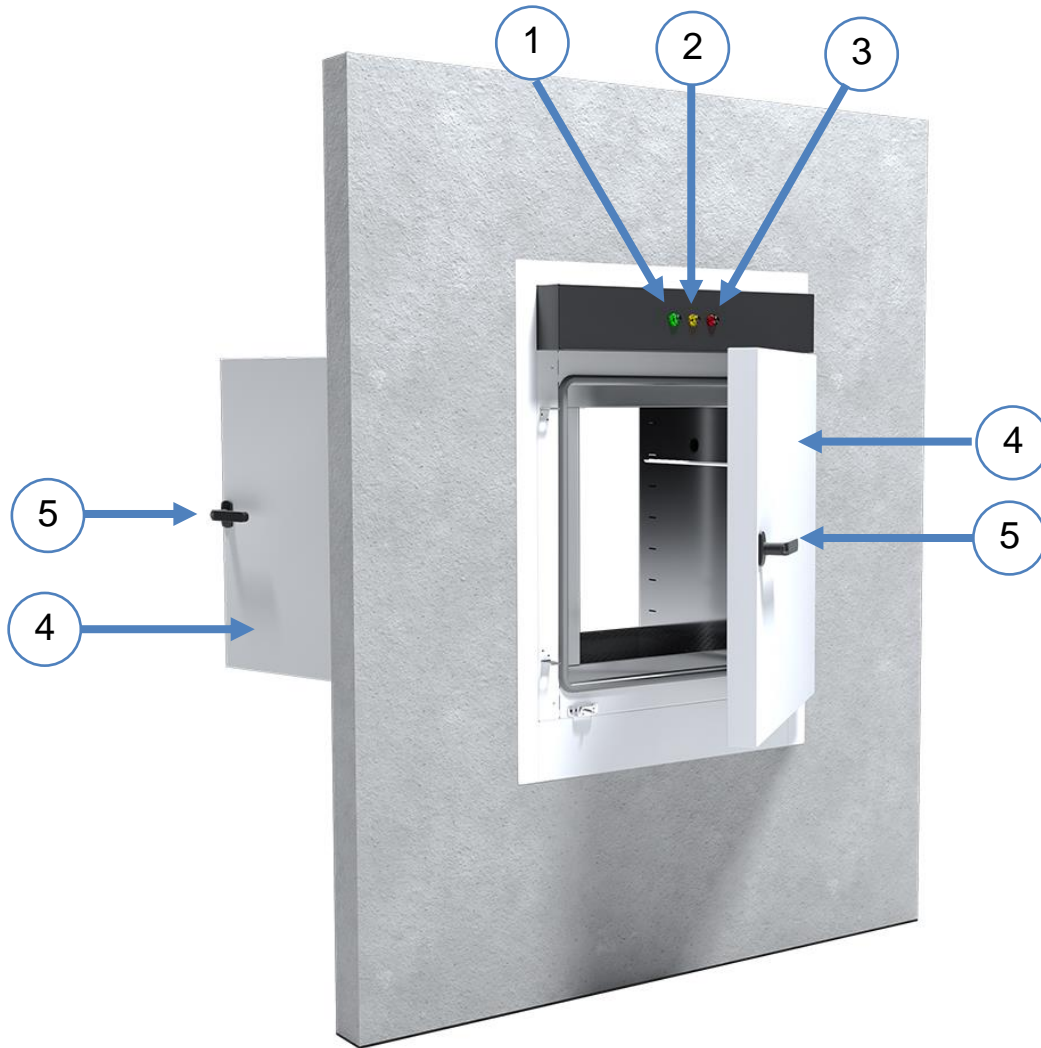

- 1) green diode – lights up when the device is turned on
- 2) yellow diode - pulsates when the set temperature is being reached; lights up when the set temperature is reached
- 3) red diode - it lights up in the event of an alarm
- 4) external solid door
- 5) handle with a key lock

5. DEVICE EQUIPMENT (STANDARD AND OPTIONAL)

5.1. External door with viewing window (optionally for CL, SL, SR)

The external door with a viewing window is an optional equipment for CL, SL, SR models (except for CL/SL 15,32).



In SL drying ovens with door with viewing window, the maximum operating temperature is lowered to +250°C at the factory.



During operation, when the temperature inside the chamber is high, do not touch components of the external door with viewing window, as there is a risk of burns. Use protective gloves to protect yourself against the effects of burns from hot components.

5.2. Internal glass door (standard for CL)

Internal glass door is a standard equipment in CL laboratory incubators. To open and close the door use the plastic handle attached to the glass.



During operation, when the temperature inside the chamber is high, do not touch the internal components and glass door, as there is a risk of burns. Use protective gloves to protect yourself against the effects of burns from hot components.



We do not recommend installing and removing internal glass door. Incorrect assembly or disassembly may result in damage to the glass and injury to the user.

5.3. HEPA filter (optionally for all units)

The HEPA filter is an optional accessory for CL incubators, SL drying ovens and sterilizers. HEPA filter is used where the highest standards of clean air are required. The equipment at the production stage is adapted to the installation of the filter. The filter has H13 class to PN-EN1822-1:2019 norm. It's located at the rear of the unit. The filter itself is delivered separately. You should place it in the square filter cover so the black gasket is outside, then screw the cover to the rear wall of the unit. Please ensure that the distance between the filter and wall is not less than 100mm.



5.4. Internal socket (optionally for CL)

An internal socket with grounding and IP44 protection is an optional equipment for CL laboratory incubators. The internal socket (depending on the model: 230V 50Hz / 230V 60Hz / 115V 60Hz) is intended for EU plugs or plugs type B. The socket can be used to connect electrical devices inside the device.



The maximum permissible load of all sockets inside the device (max. 3 pcs.) is 200 [W].



In laboratory incubators with internal socket the maximum operating temperature is lowered to +70°C at the factory.



Always make sure that the safety rules for working with electrical devices are followed!

5.5. Door lock (standard for all units)

All devices have a key lock. In the models CL, SL, SR, SRWP the key lock is situated in the door handle. Two keys are supplied with the device (hung on the back of the device). Together with SRWP model 4 keys are provided.



5.6. Access port for external sensor (standard for all units)

A Ø30 mm access port can be used to insert an external temperature sensor for independent temperature control inside the device. The access port has been secured with a rubber plug. The plug should cover the access port while the unit is operating. If multiple cables have been inserted through the access port and it is not possible to use the plug, secure the access port with adhesive tape. If you leave the access port open, it may affect temperature fluctuation and variation inside the chamber.



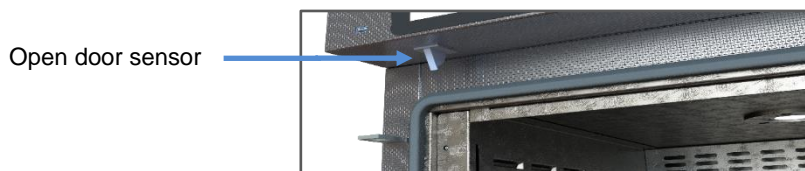

5.7. Open door alarm (standard for all units)

All units have been equipped with an open door sensor. If you open the door, the icon:  will appear (the number above the icon presents open door counter. Press the icon to cancel the counter. The counter is also cancelled by turning of the device). If the door remains open longer than the time set by the user (30s, 1 min, 2 min, 5 min, 10 min) an acoustic signal, red pulsating alarm bar and „open door” alarm with active status will appear.



In SRWP pass-through sterilizers, the open door sensor is located on the front and back of the device - the open door alarm is activated for the front and rear door.





5.8. Internal light (optionally for all units)

Internal light is optional for CL, SL, SR and SRWP devices. Internal light is integrated with an open door sensor. When the light switches on, the icon  will appear on the display. For devices with door with viewing window, pressing the icon  allows you to turn the light ON or OFF (the light is not integrated with the open door sensor).

	In incubators with internal light, the maximum operating temperature is lowered to + 70°C at the factory. In drying ovens with internal light, the maximum operating temperature is factory reduced to + 250°C.
---	---

5.9. USB port (standard for all units)

The USB port on the front panel is used only to transfer data from the device's internal memory to the flash drive. To do this, insert the flash drive into the USB port on the front panel and then:

- go to the main menu ,
- go to the data record ,
- press  and choose type of the file: *.csv, or *.plx.
- press . Data has been copied.



After copying the data to the USB flash drive, before removing it from the USB socket, it should be unmounted by pressing the icon  in the top drop-down list (Figure 1). If the pendrive is not unmounted after connecting to the computer, a message about pendrive damage may be displayed with a repair proposal, when actually the pendrive is not damaged

Figure 1 Unmounting USB flash drive



Data saved in the *.csv file can be opened in a spreadsheet. Data saved as *.plx can be opened in the Lab Desk program (additionally paid option). This program allows, among others, for data preview in the form of a table or a graph. It also allows you to prepare a statistic report for a selected range of data, more information [Section 6.9](#).

5.10. Display battery backup (optionally for CL, SL, SLWN, SR, SRWP)

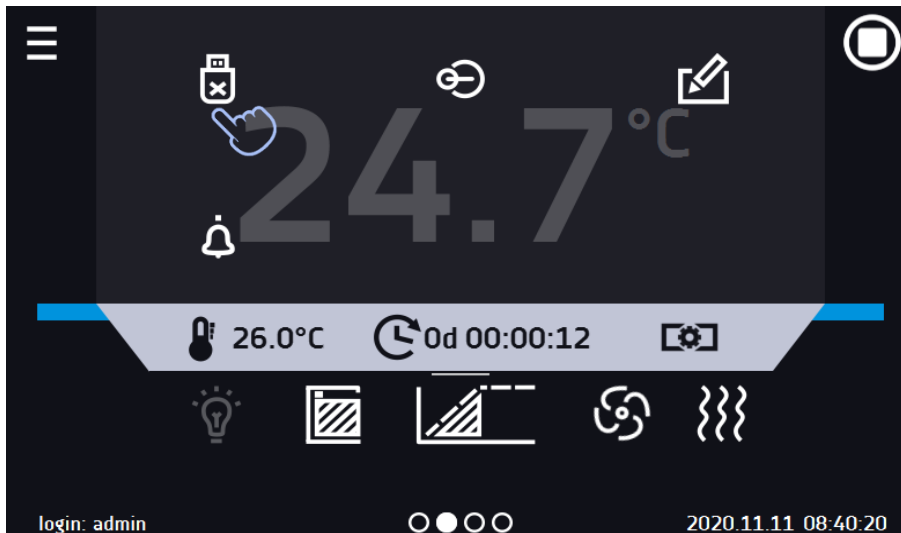
Units in the SMART version can be optionally equipped with a battery backup of the display. The power loss and switching to the battery backup display mode is signaled by a pulsating red frame around the display and a sound signal (if it is turned on). In the battery backup display mode, all parameters are displayed, ie temperature. Other alarms, e.g. exceeding the temperature range, are also signaled.

In order to extend the battery life, the display is dimmed all the time. Batteries are automatically charged in AC mode.



Batteries should be replaced every 12 months. When it is time to replace the battery, a message will appear on the display, see [Figure 2](#). During the warranty period, the replacement should be performed by an authorized service. Otherwise, you will lose your warranty.

Figure 2 Battery replacement message

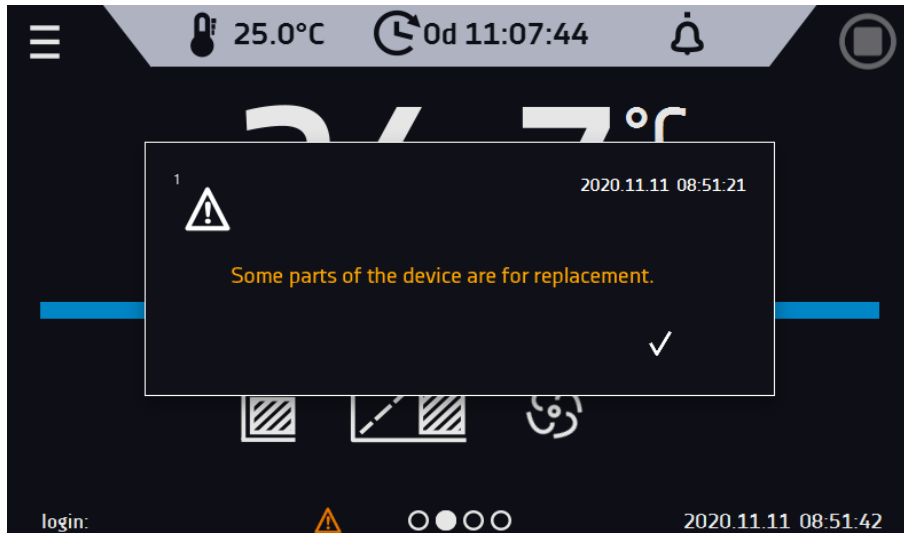

5.11. Consumables

Consumables during normal operation are:

- silicone door seal - in all units,
- chamber fan - in equipment with forced air convection,
- interior lighting bulb - in units with the option of interior lighting.

6. DEVICE OPERATION



This symbol means that a given window can be moved in the direction shown in the picture.

6.1. External memory (USB flash drive)

The external memory (USB flash drive) allows to copy: instruction manual, data record, event log and service log from the device memory. Before first use, the USB flash drive should be formatted in the FAT 32 file system. Insert the device in the USB slot on the front of the device next to the display. Wait a few seconds, the correct reading is indicated by the message „USB flashdrive connected” at the bottom of the screen.



After copying the data to the USB flash drive, before removing it from the USB socket, it should be unmounted (see [Section 5.8](#)).



USB slot is used to connect **only** a flash memory – a pendrive or a card reader with a memory card. Connecting any other device (e.g. external hard drive) without consultation is not authorized by the manufacturer and may damage the USB slot.

6.2. First boot

During the first boot, the screen (Figure 3) will display information about saving the "Download" folder (with instruction manual in pdf format) on the USB flash drive. In order to do it, insert the USB flash drive and wait a second for hardware detection, then press .

If you press  you quit downloading the folder. The window will appear again during the next boot. You can tick „Don't show again" so that the window will not be displayed after switching on the device. You can always download the "Download" folder in the Info submenu. More information [Section 6.11](#).

Figure 3 Downloading files



6.3. Main screen

After switching on the device, the main screen (Figure 4) appears. It contains the information about the device status. After starting the program, additional information appears on the screen (Figure 5).

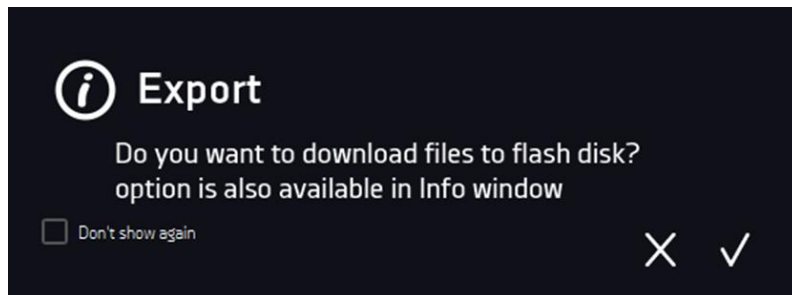
Figure 4 Main screen

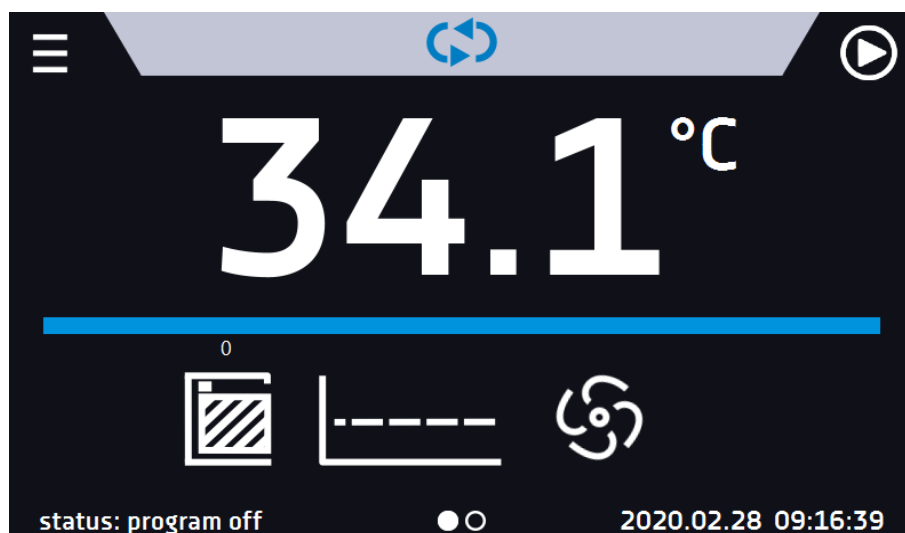
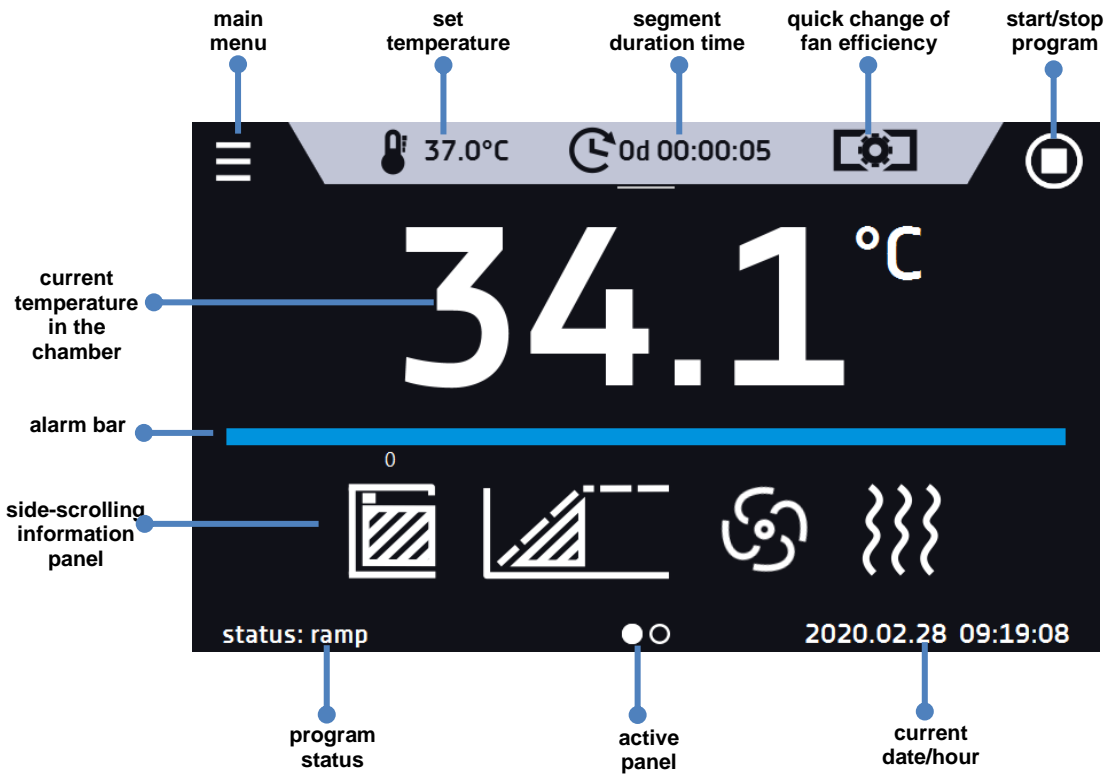

Figure 5 Main screen – running program



6.3.1. Information panel

There are two different windows in the information panel. Switching between them is done by swiping the finger left or right.



Figure 6 Information panel



The icon  indicates information about which window is active.

6.3.1.1. Alarms panel

The icon  which is on the second page of the information panel, allows you to go to the alarms panel.

Figure 7 Icon: Alarms panel



In the alarms panel (Figure 8) there's a list with active alarms or the alarms that have occurred but have not been confirmed. When the alarm is active, the alarm bar is red and the alarm event is displayed in the list with the status "active". When the alarm event stops, the state changes to "inactive".

- “**delete**” button – confirms and removes the alarm from the list (only inactive alarms can be deleted),
- “**confirm**” button – confirms an alarm,
- “**details**” button – displays a preview of all instances of selected alarm (Figure 9).

Figure 8 Alarms panel

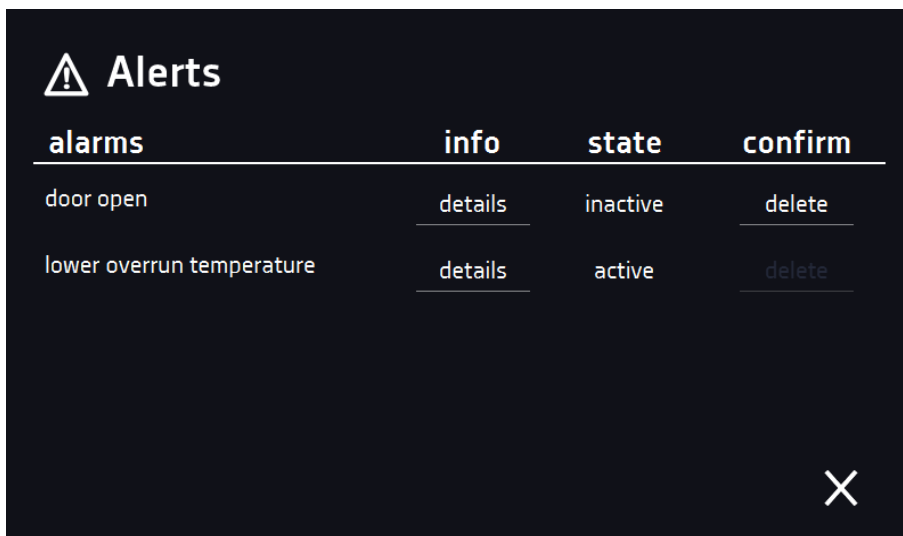
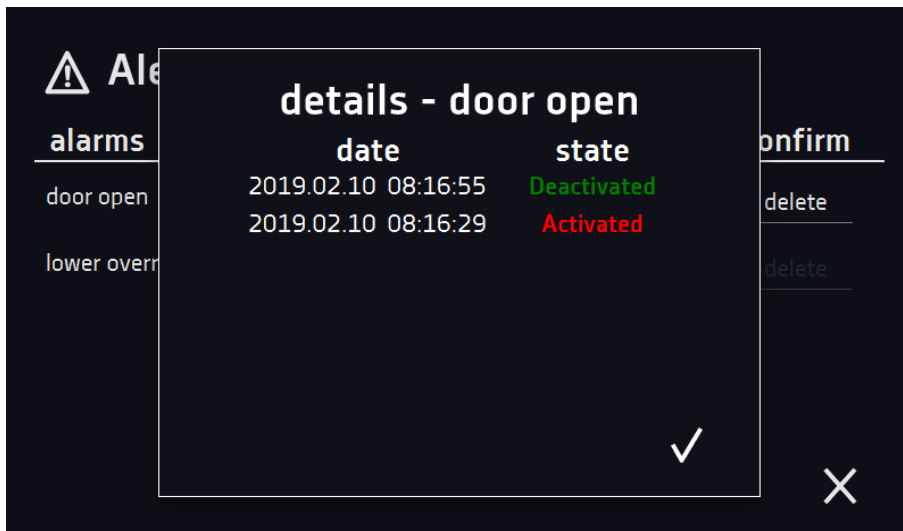

Figure 9 Alarm details



6.3.1.2. Status panel

The icon  which is on the second page of the information panel, allows you to go to the status panel.

Figure 10 Icon: Status panel







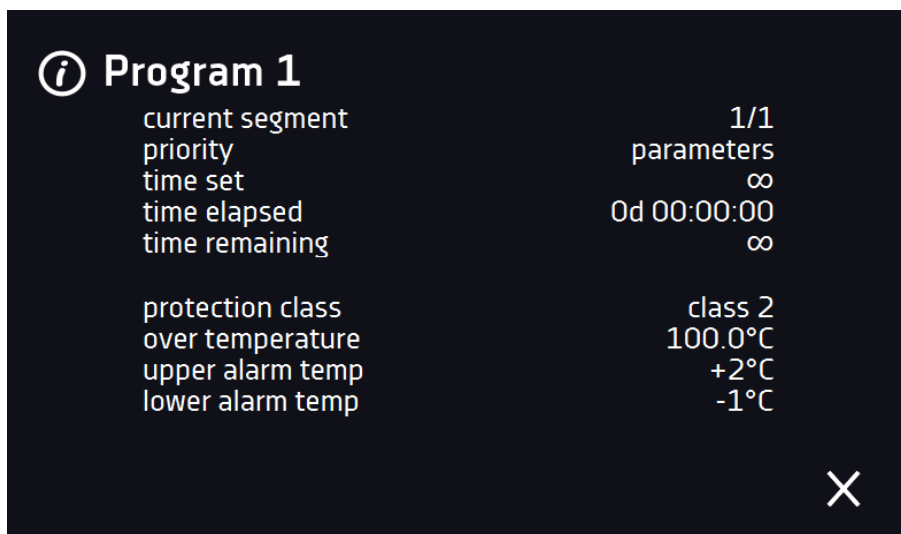













The status of the device is indicated also by description.



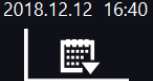













Figure 11 Status – description



program name	the name of running program
current segment	currently running segment / total number of segments in the program
priority	of time or parameters
time set	set time of running segment
time elapsed	elapsed time since the segment has started
time remaining	remaining time until the end of the segment
current loop	currently performing cycle/ total number of cycles to perform
protection class over temperature under temperature	information about the protection temperature of a running or completed program. The protection parameters can be set in the program parameters
upper alarm temp lower alarm temp	information about set alarms, separately for upper and lower alarm temperature. Setting of the alarms

6.3.2. The meaning of icons and symbols

	The icon allows you to go to the main screen.
	Automatic return to the home screen. Factory setting: disabled.
	The icon allows you to go to the main menu.
	Automatic screen lock. Factory setting: disabled.
	Unmounting the USB flash drive before removing it from the USB socket.
	Internal light is switched on. The icon appears in the devices with the internal light (OWW). Light switched off – icon inactive. By clicking the icon  on the status panel you can manually turn on / off the light (applies to devices with the door with viewing window).
 	Closed door, open door. The number above the icon presents open door counter. Press the icon to cancel the counter. The counter is also cancelled by turning of the device
	In the devices with forced air convection (CLW, SLW, SRW, SRWP): fan icon. Rotating icon shows that the fan is running. Quick Change function - clicking the icon allows you to change the fan efficiency (without editing the program) in the range of 0% ... 100% for CLW/SLW/SRW/SRWP 15-115) or 10%...100% for CLW/SLW/SRWP 180-1000.
	Ramp status: Chamber is currently heating up.
	Set temperature is reached.
	The program will start on the given date / time. Start delay activated.
	Icon is visible only when the chamber is heating up.
	Available when the program is running. Clicking the icon allows you to quickly change the set temperature (Quick Change function).
	When the program is running, click the icon to quickly change the time of program duration (Quick Change function). Indicates the time that has elapsed from the program start.
	Countdown of the time remaining to the end of the program.
 	The arrow icon allows navigation between: segments, program parameters and summary.

	Starting the selected program. In the list of programs - the program is running.
	Stopping the program.
	Adding a new program to the program list. The user can create up to 5 programs.
	Editing the selected program from the list. In the program list, a new program has been created but not approved yet.
	Removing selected program from the list.
	Going to alarms panel.
	Going to the status panel with information about the program parameters.
	Going to the menu to create, edit, delete and start programs.
	Canceling adding or editing of the program. Canceling changes.
	Editing individual program segments (the program can have max. 6 segments).
	Immediate start of the program selected from the program list.
	Delayed start of the program from the list of programs. The program starts according to the set date and time.
	Going to the SMART program (Quick Program function).
	Turning off the alarm sound. Critical alarms (i.e. damage to the temperature sensor, temperature, protection etc.) continue emitting a sound.
	When the program is running, click the icon to quickly change the fan efficiency (Quick Change function).
	In the program editing/creating mode: the degree of air-flap opening. In the operating mode (program started) clicking on the icon allows you to quickly change the degree of opening of the air-flap without having to edit the program.
	Active STM function (Smart Temperature Monitor) informs the user about the problem of reaching or maintaining the set temperature. <ul style="list-style-type: none"> • white color - option enabled, the program is stopped • blue color - option enabled, the program is running • red color - warning about problems with reaching / maintaining the temperature

6.3.3. Upper expandable and configurable menu

When the program is running, in the upper part of the main screen there's a bar menu with parameter icons (temperature, time, fan efficiency - for CLW, SLW, SRW, SRWP and degree of opening of the air-flap) which can be quickly changed (Quick Change).

Depending on the model, after swiping your finger down (Figure 12, Figure 13) you will see icons for all parameters which can be quickly changed (more information Section 6.7.). Among the options available in the bar you will find the following icons:





-  USB flash drive unmounting – more information Section 5.9.
-  mute option. Critical alarms (i.e. damage to the temperature sensor, temperature, protection etc.) continue emitting a sound, see Section 6.14.1.
- Quick Change (more information Section 6.7.) of:
 -  program duration time,
 -  set temperature,
 -  fan efficiency and degree of opening of the air-flap.

Figure 12 Upper menu when the program is running

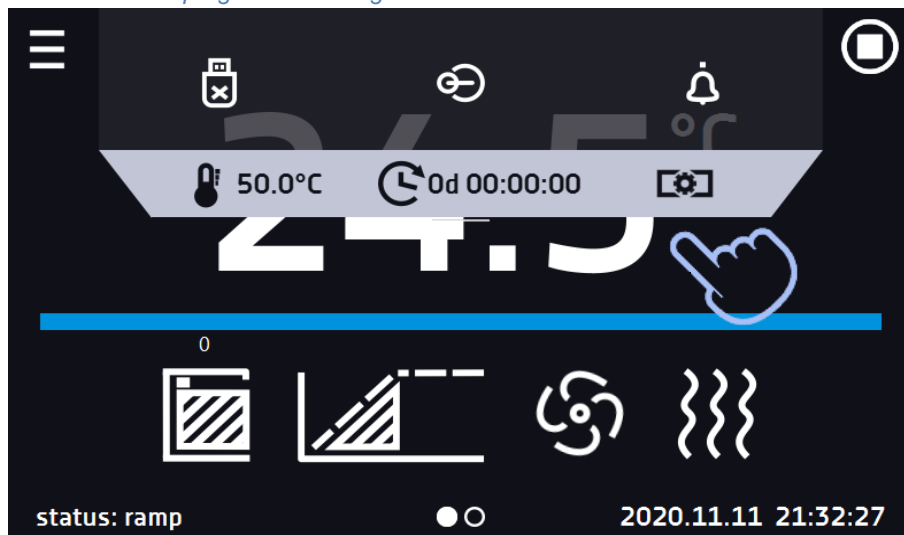
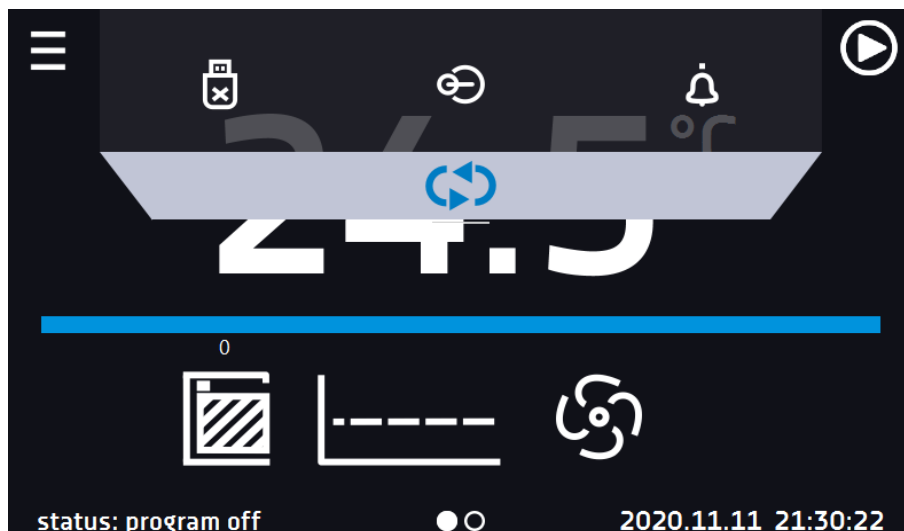
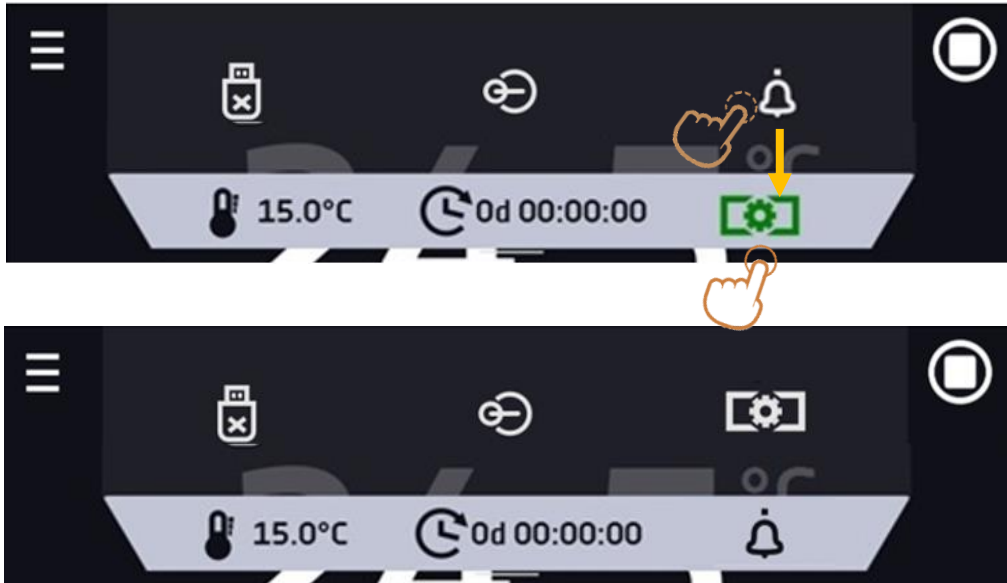

Figure 13 Upper menu when the program is stopped





Positions available on the upper bar can be personalized. Just drag the selected icon to a new location (Figure 14)

Figure 14 Changing icon's position



6.3.4. Alarm bar

The Alarm Bar is a quick visual information about the device status. The colour of the bar indicates the status of the device:

-  – blue - the device is working properly
-  – red bar and pulsating frame – active alarm

6.4. Quick Program

Quick program allows you to quickly start the program from the main screen position without having to enter to the menu .



The Quick program has several features that guarantee its uninterrupted operation:

- you can not set the duration of the program - time is always set to infinity,
- if the display fails, the program continues,
- after the power supply is resumed (after its failure), the program continues,
- to prevent the program from stopping accidentally, the STOP button was removed from the main window (Figure 15).

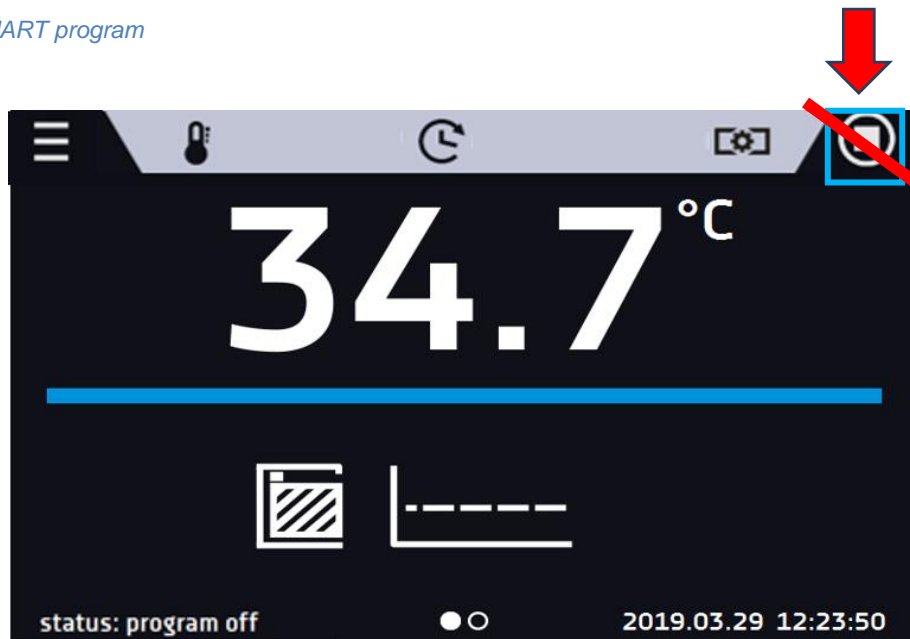
Figure 15 SMART program



In order to go to Quick program click the icon  in the main screen. By clicking the appropriate icon you can set:

-  temperature (Figure 16)
-  fan efficiency
-  degree of opening of the air-flap







Clicking the icon  starts the program in continuous mode (time set to infinity).

Figure 16 Starting the Quick Program

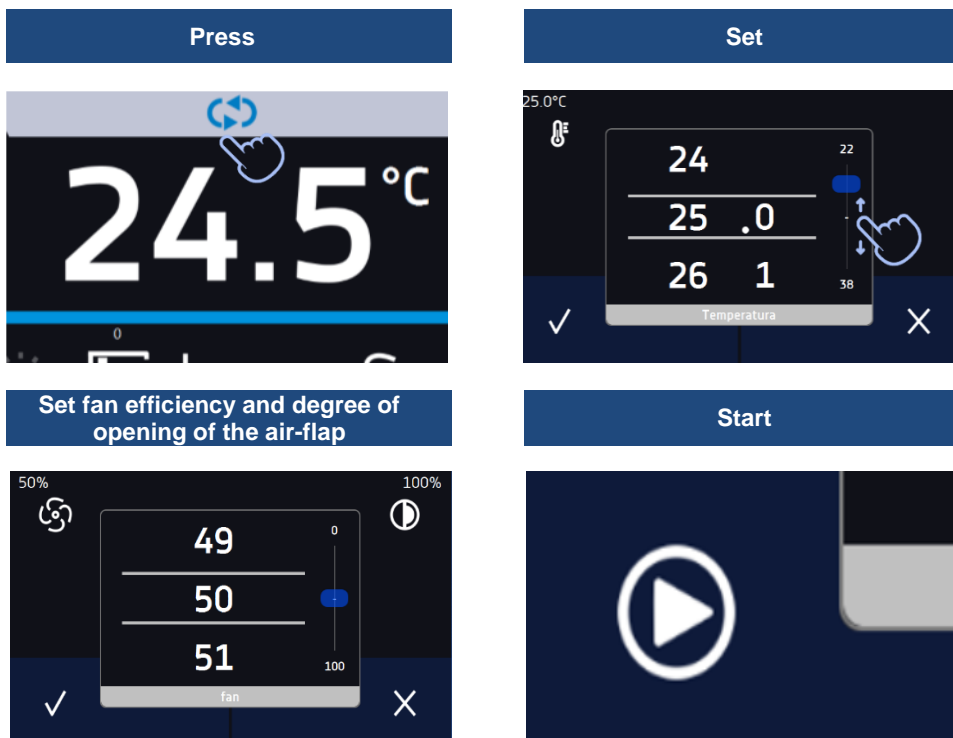

Stopping a Quick program has been made difficult on purpose (this prevents the program from being stopped accidentally) – to stop a program, you have to go to the menu , click the program window  and keep pressing STOP button  for 5 seconds.

The over and under temperature protections are set automatically: the over temperature protection is the set temperature + 5°C, the under temperature protection is the set temperature -5°C.

When the Quick program is running you can change the parameters (temperature, fan, air-flap) by pressing the icon  or . During next launch of the Quick program, your previous settings will be remembered.

After configuration of the Quick Program, it appears in the programs list (*Figure 17*). Quick Program is displayed at the top of the list by default.

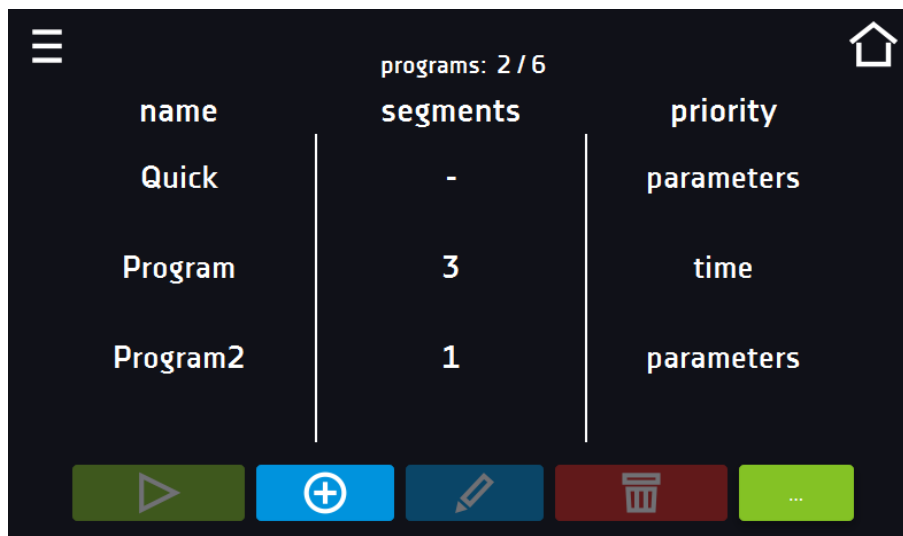

Figure 17 Quick program on programs list



name	segments	priority
Quick	-	parameters
Program	3	time
Program2	1	parameters





In Quick Program editing mode, you can change:

- settings of the data recording interval,
- settings of the protection class.

When the program is running you can change the parameters (temperature, air-flap and fan if available) by pressing the icon  or . During next launch of the Quick program, your previous settings will be remembered.

6.5. Programs

In this panel (*Figure 18*) you can run the selected program, add a new one, edit the program or delete it. The user can create 5 independent programs.

-  Start the selected program
-  Stop the program
-  Add a new program
-  Edit the selected program



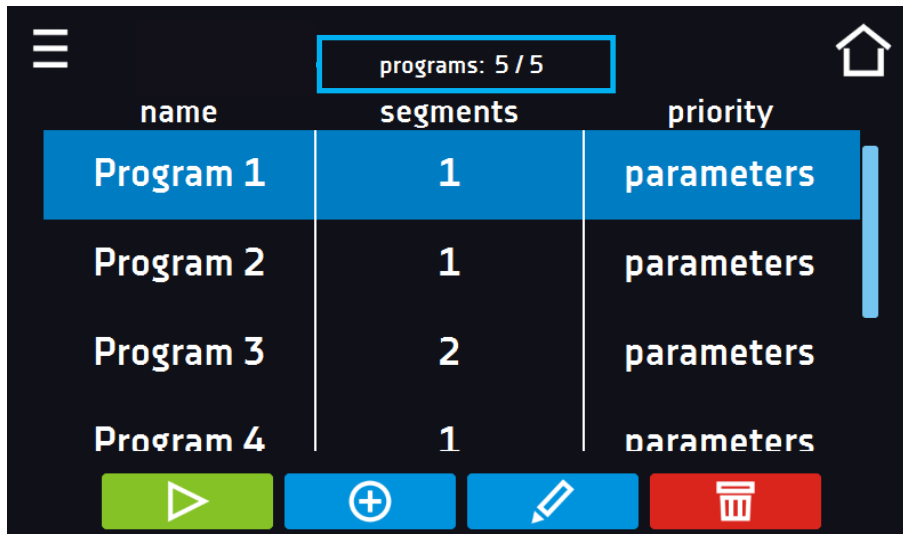

Delete the selected program

Figure 18 List of programs



Information on the number of created programs / the maximum number of programs that can be created is at the top of the screen (programs: 5/5).

6.5.1. Creating / editing a program

Press the button  or , and a panel with program parameters will appear (Figure 19).

The program name is given automatically and it can't be changed.

In this panel you can set:

- **Segments number** – max. 6 segments
- **Interval** – frequency of saving the data in the data record (1 min, 2 min, 5 min, 10 min, 15 min, 30 min, 1 h)
- **Protection class** – more information [Section 6.5.3](#).
- **Protection temperature** – temperature range for the protection class, more information [Section 6.5.4](#).
- **Priority** – the priority of time or parameters, more information [Section 6.5.5](#).
- **Loop** – the number of program repetitions, more information [Section 6.5.6](#).
- **Bolt** - locking the door opening (only in SR)



It is not possible to disable the bolt in SRWP pass-through sterilizers.

Figure 19 Program parameters

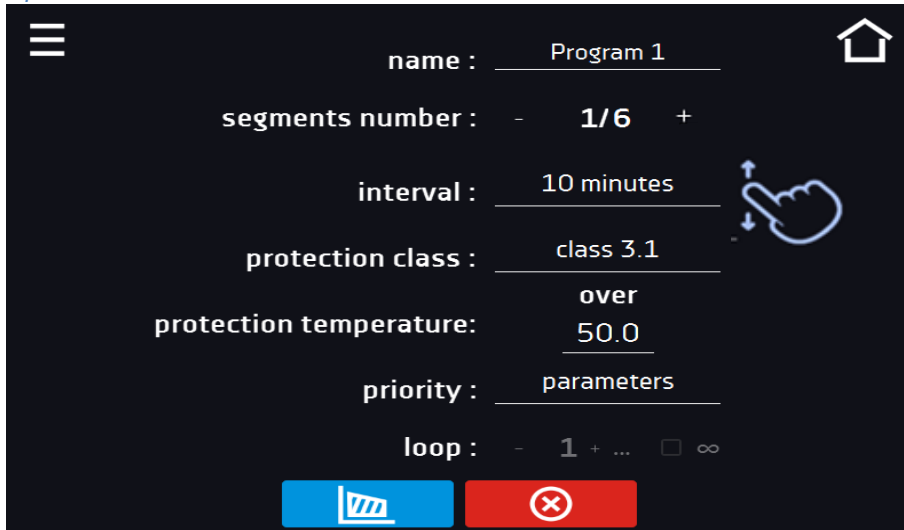

Cancels adding or editing of the program.



Going to the edition of program segments.



With more parameters, the window can be scrolled up and down.

6.5.2. Segments edition

For each of the 5 programs, you can set maximum 6-segment time-temperature profiles that allow you to gradually increase or decrease the incubation temperature of the samples. This can e.g. protect the sample from so-called thermal shock. Example of program operation with programmed segments:

Program 1

segment1: temp. 30°C, time 2 hours (after reaching the temperature 30°C, it is maintained for 2 hours)

segment2: temp. 40°C, time 3 hours (after reaching the temperature 40°C, it is maintained for 3 hours)

segment3: temp. 50°C, time 3 hours (after reaching the temperature 50°C, it is maintained for 3 hours)

segment4: temp. 60°C, time 2 hours (after reaching the temperature 60°C, it is maintained for 2 hours)

segment5: temp. 70°C, time 2 hours (after reaching the temperature 70°C, it is maintained for 2 hours)

segment6: temp. 80°C, time 1 hours (after reaching the temperature 80°C, it is maintained for 1 hour)

Press the button  and the first program segment will appear (Figure 20).

In this window you can set:

- **temperature** – target temperature which the device is to achieve in this segment (can't be higher than over temperature protection -5°C),
- **time** – the time of maintaining the set temperature ([d hh:mm]) in days, hours and minutes. It is possible to select continuous work ∞ in the last segment,
- **ramp time** – the time of reaching the set temperature ([d hh:mm]) in days, hours, minutes,
- **fan** - fan efficiency in percent,
- **air-flap** – degree of opening of the air-flap,
- **fan ramp** – fan efficiency when reaching the set temperature,
- **air-flap ramp** - degree of opening of the air-flap when reaching the set temperature.

Instruction manual CL, SL, SLWN, SR, SRWP SMART

The active value is highlighted in blue. The item highlighted in red means that the value is out of range and you should enter another one, e.g. the temperature is above / below the operating range of the device or the protection temperature.



The fan efficiency set to 100% is the default value. Reducing the fan efficiency may cause improper operation of the device, e.g. worse fluctuation and variation of temperature.

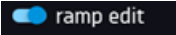

Ramp time - setting a short time will not accelerate reaching the ramp, but the ramp will be reached in the shortest possible time depending on the set temperature, ambient conditions and the possibilities of the heating system in the device.

The ramp parameters are factory set in accordance with the manufacturer's instructions. If it is necessary to set individual parameters when reaching the segment temperature, activate the ramp edition field  and set your own values.



With more parameters, the window can be scrolled up and down.

Figure 20 Program segment edition

<<< segment 1/2 >>>

temperature [°C] 35.0

time [d hh:mm] 0 02 00

fan [%] 90

flap [%] 50

ramp edit

time [d hh:mm] 0 02 00

<<< segment 2/2 >>>

temperature [°C] 50.0

time [d hh:mm] ∞

fan [%] 100

flap [%] 0

ramp edit

time [d hh:mm] ∞

The navigation between: segments, program parameters and summary is done by touching the icon .



If, when editing a program, you automatically return to the home screen, the edited program will not be lost, but saved as a draft (see below).

After configuring all segments, a window with the security class is displayed ([Figure 21](#)). For class 2.0 (standard) and 3.1 (option) you can set the protection temperature.

([Figure 21](#)). Security class 2.0

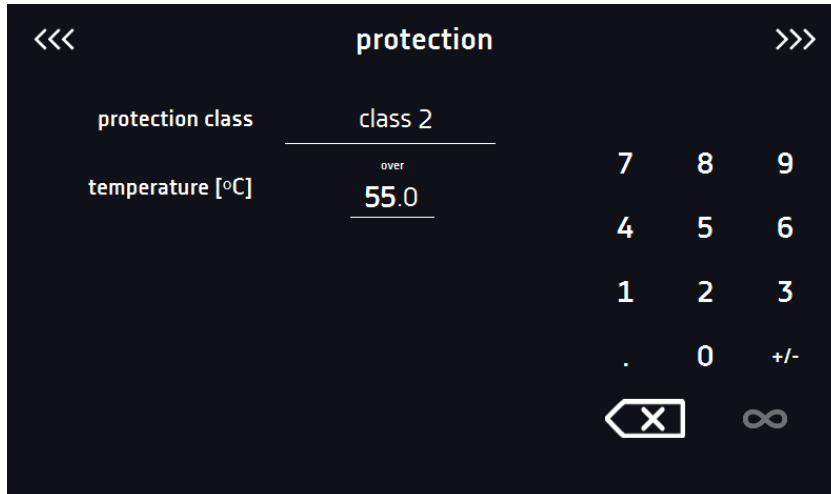

([Figure 22](#)). Security class 3.1.

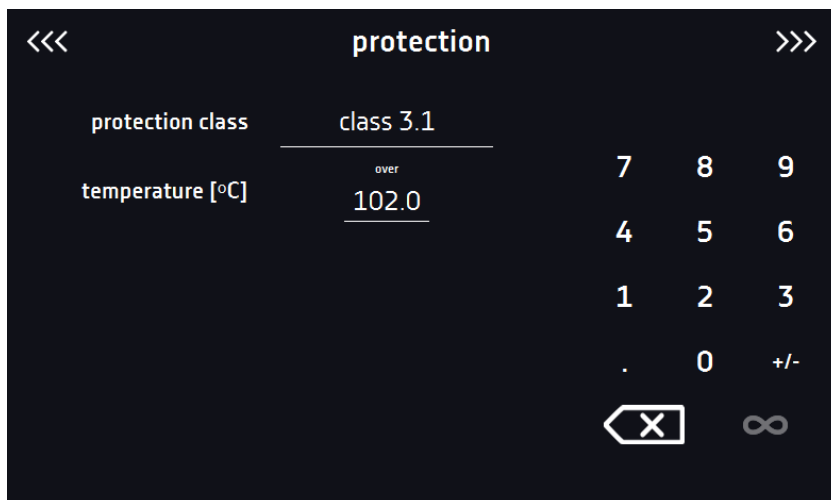

After switching to the program edition, the information about the possibility of continuing changes in the program settings appears ([Figure 23](#)).

Figure 23

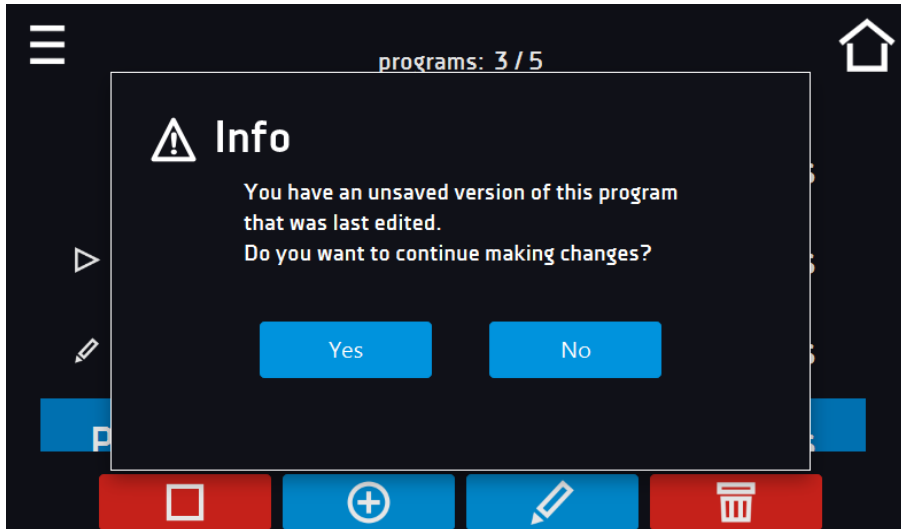

6.5.2.1. Summary of segments

In the segments summary (Figure 24) all segments can be seen along with introduced parameters:

- number of segments,
- temperature, duration time, target time of reaching temperature of a given segment,
- fan efficiency,
- degree of opening of the air-flap

Figure 24 The summary of the segment

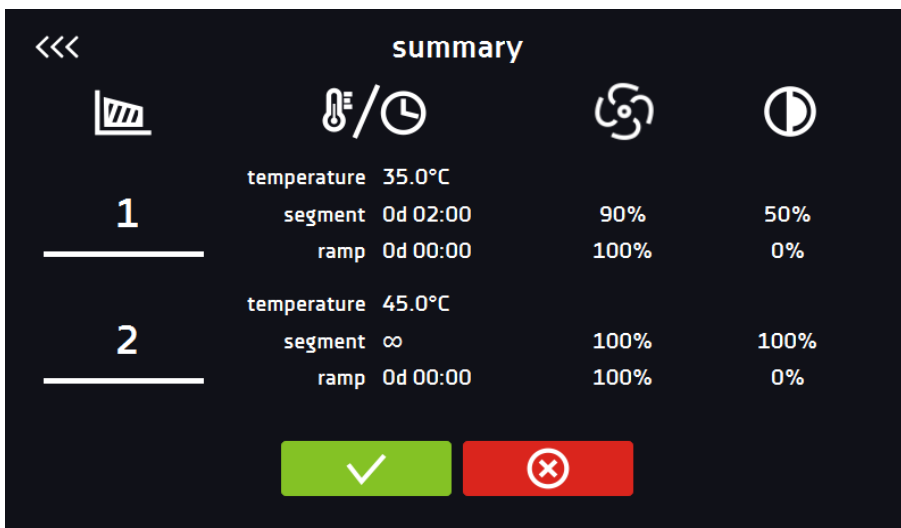

Confirms and saves the changes.



Cancel the entered changes in the segments and goes to program parameters.



With more parameters, the window can be scrolled up and down.

6.5.3. Protection class

The device is equipped with sample protection – temperature protection which is carried out on the basis of the temperature value measured by an independent temperature sensor, the so-called security sensor. The main aim of sample protection is to protect against uncontrolled rise or fall of temperature. When activated, the relay disconnects the heating circuit.

Figure 25 Confirmation of protection alarm class 2.0

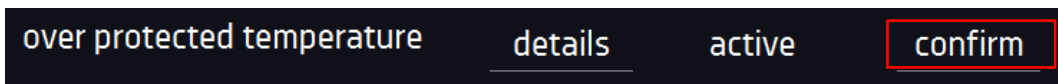

For devices with heating system there are two protection classes:

Standard protection class:

Class 2.0 according to DIN 12880 – the user programs the protection temperature and once it's exceeded, the heaters are cut off. To restart the device, the user must turn the device off and on. The temperature in the chamber must naturally return to a temperature below the protection temperature.

Optionally:

Class 3.1 according to DIN 12880 – the user programs the protection temperature and once it's exceeded (caused by a failure), the heaters are cut off. When the temperature returns to the allowed range, the device resumes operation.

The set temperature in the segment cannot be higher than the over temperature protection minus 2°C, e.g. the over temperature protection is 50°C, therefore the maximum set temperature in the segment that can be set is 48°C.

6.5.4. Temperature protection class 3.1 (optionally)

The temperature protection value for protection class 3.1 is:

- from the set temperature + 2°C to the maximum operating temperature of the device + 10°C.

For units with heating, the lower limit of the temperature setting must be considered, i.e. 5°C above the ambient temperature.

6.5.5. Priority

Can be set in terms of:

Parameters:

In the program without ramp – the device starts the countdown of the segment time when the set temperature is reached.

In the program with ramp – first, the device counts down the time of the ramp and then proceeds to the segment countdown when the set temperature is reached. Regardless of whether the time of ramp elapsed.



It may happen that the device failed to reach the set temperature within the set time because the reaching time was too short. In such situation the reaching time will be prolonged and the segment's time countdown will start when the set temperature will be reached.

Time:

In the program without ramp – the device starts counting down the segment time when the program is started. Regardless of whether the temperature has been reached.

In the program with ramp – first, the device counts down the ramp time and after its expiry it proceeds to the countdown of the segment time. Regardless of whether the temperature has been reached.



It may happen that the time of reaching was too short and the device failed to reach the set temperature within the set time. Then the countdown of the segment time will start before reaching the set temperature. Thus, the actual time of device operating in the set temperature will be shortened.

6.5.6. Loop

The option is available if the number of segments is equal to 2 or more. When the program finishes the last segment, the device starts the program again from the first segment. You can define if the program should be carried out once (loop: 1) or multiple times (loop: 2 to 255). In order to set the program to be carried out continuously, tick the „∞” option. If the time of the last segment is set to infinity, it will be treated as infinite only in the last cycle. In other cycles it will be treated as 0.

Example:

Loop:3

segment1: temp. 30°C, time 2 h

segment2: temp. 40°C, time 2 h,

segment3: temp. 80°C, time „∞”

The device will run segment1 and segment2 three times and then will go to segment3 which will last indefinitely. CL incubators and SL drying ovens do not have a cooling system, so the temperature in the chamber decreases naturally.

6.5.7. SR and SRWP devices – factory predefined sterilization programs

The SR and SRWP sterilizers have 3 predefined sterilization programs created at the factory:

Program 1: temperature 160°C, duration time 2 h

Program 2: temperature 180°C, duration time 45 min

Program 3: temperature 200°C duration time 30 min

Predefined programs can NOT be deleted. Moreover:

- you can't change settings of the air-flap – it's always closed during sterilization,
- you can't change the door lock settings which are always blocked during sterilization,
- at the start of the program the door must be closed – they are automatically locked,
- in the event of a door lock failure while the program is running, the program will stop (a message and a record in the event log will appear),
- when the program is started, the ventilation air-flap is automatically closed and user is not able to change air-flap settings during program operation.



In addition to the predefined sterilization programs, 5 regular programs are available to the user. They can be freely configured including settings of the air-flap and door lock.

In the event of a power supply failure or program interruption, after restarting the device, the sterilization program is restarted (runs from the beginning) - this ensures that the sterilization parameters (time and temperature) are preserved.

6.6. Starting the program

The created program can be started in two ways:

6.6.1. The first way

- Go to the main menu  and press the icon „programs”  (Figure 26).

- Then select the program you want to activate and press „start” button  (Figure 27).

Figure 26 Main menu

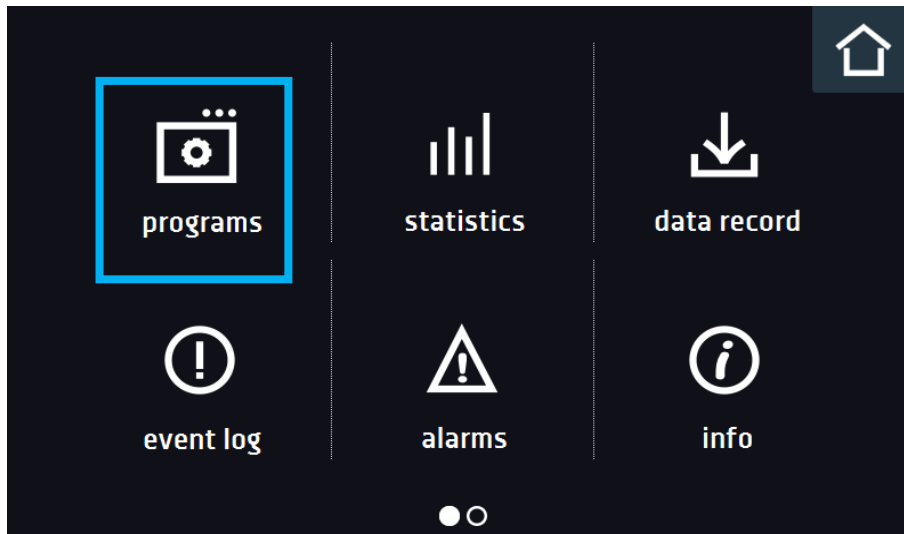
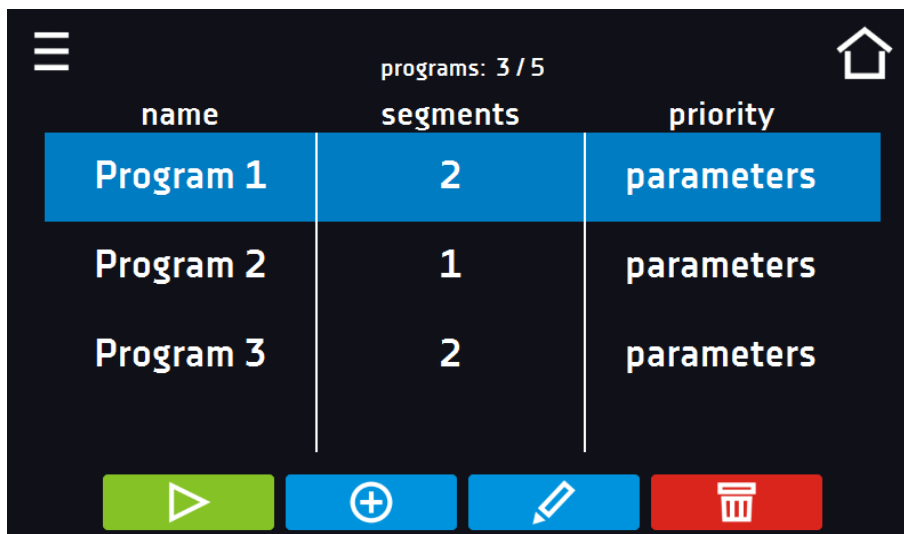

Figure 27 Program management menu







If the program is running, the symbol  appears next to the program name on the list. The symbol  means that the program has been edited, but the changes have not been confirmed (Figure 28).

Figure 28 List of programs with the selected status

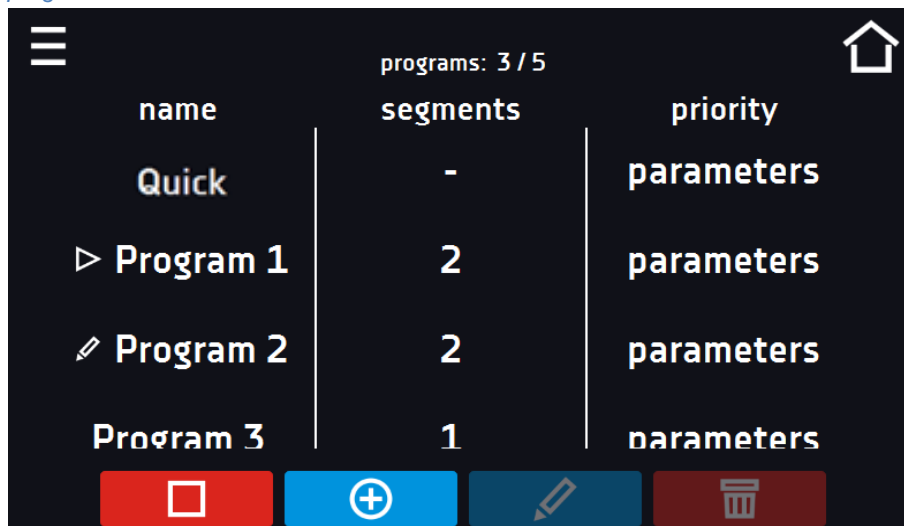

6.6.2. The second way

- In the main screen (Figure 29) press the icon in the upper right corner .
- Select the program you want to start (Figure 30). You have two additional options to start the program:



Immediate start of the program.



Scheduled program start according to the set date and time.

Figure 29 Main screen

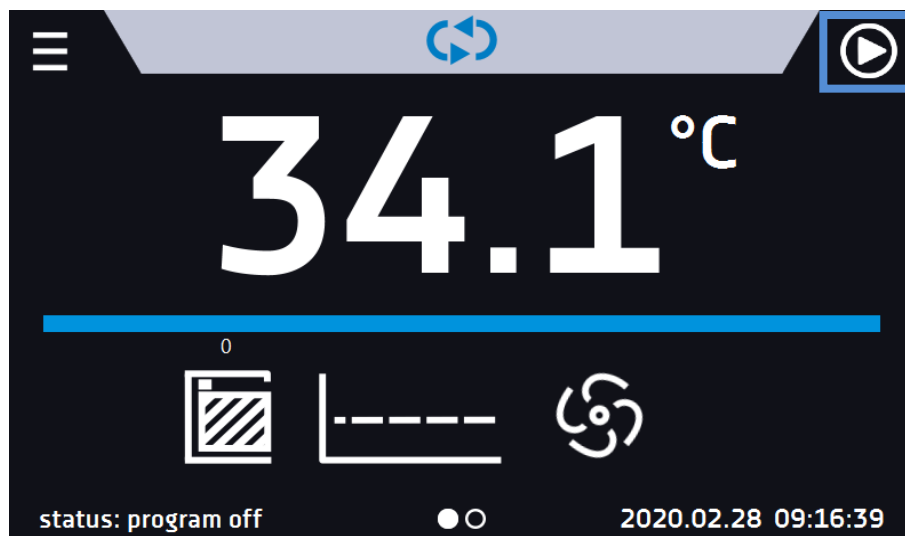





Figure 30 Selection of the program from the list

PROGRAM			
name	segments	priority	
Program 1	2	parameters	
Program 2	1	parameters	



A delayed start of backdated program is possible (up to 7 days back). This is possible for the programs with time priority. Program segments that would last from the back date to the current date will be skipped.



If the program is running, the symbol  appears next to the program name on the list.

6.7. Quick Change of parameters



Although the ramp time has been included in the program, the Quick Change of parameters will take place immediately while the temperature is being reached.

6.7.1. Quick change of set temperature

In order to quickly change the value of set temperature of a running program, press the icon  in the main screen (Figure 31). The value of the temperature should be selected by scrolling the list up or down (Figure 32). Click  to confirm the change. In the Quick Change program, the temperature protection is set automatically and the upper protection is the set temperature of +5°C, the lower protection is the set temperature of -5°C. **Please note that incubators and dryers have a lower temperature range of 5°C above ambient temperature.**

The temperature can't be higher than the over temperature protection -2°C and lower than the under temperature protection +2°C.

Figure 31 Quick temperature change – selection

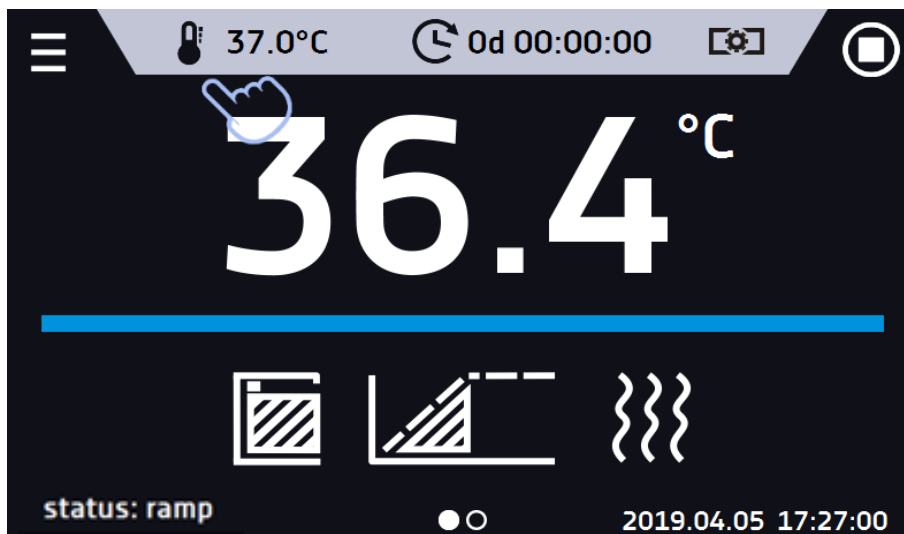
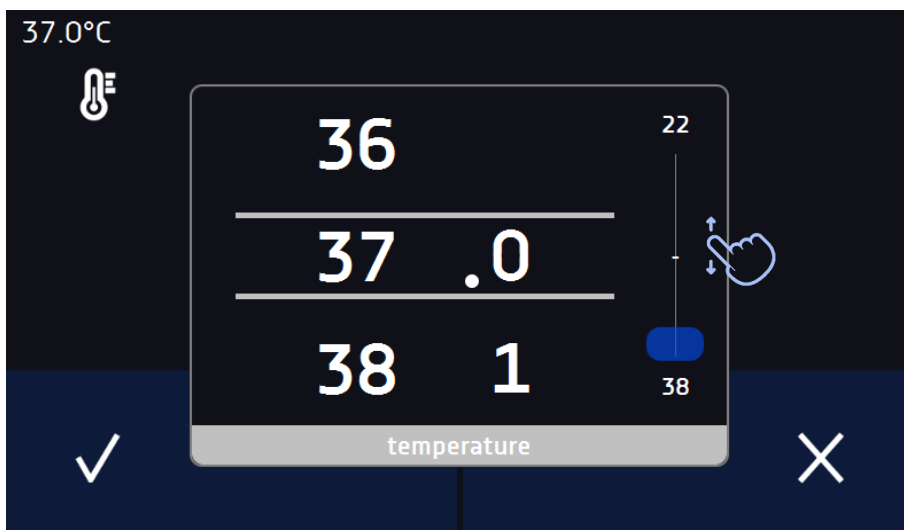





Figure 32 Quick temperature change - setting the value



6.7.2. Quick change of set time

In order to quickly change the duration time of a running program, press the icon  in the main screen (Figure 33). Select the number of days, hours and minutes by scrolling the list up or down (Figure 34). Click  to confirm the change. To set the continuous work press .

To change the way of displaying the time, press::



– to display the elapsed time



– to display the remaining time

To change only the way of displaying, you do not have to confirm it by .

Figure 33 Quick change of the set time – selection

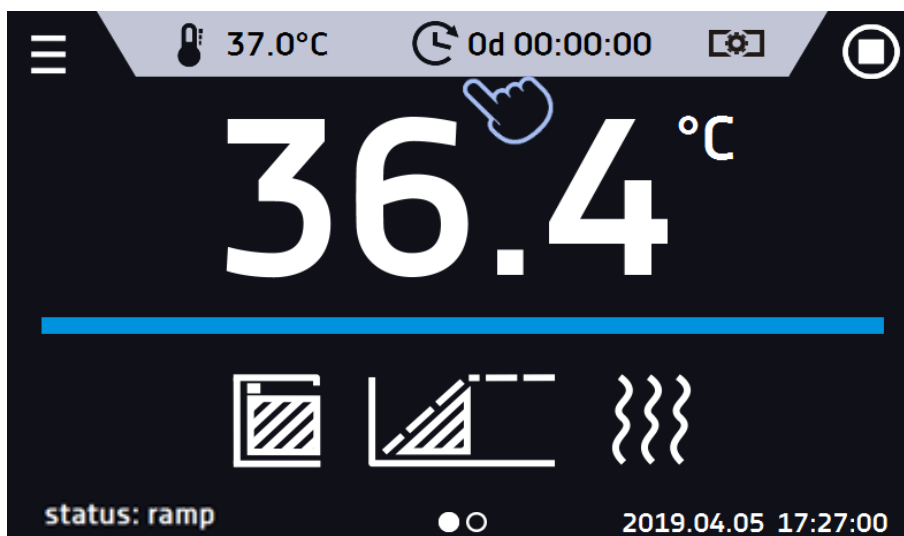
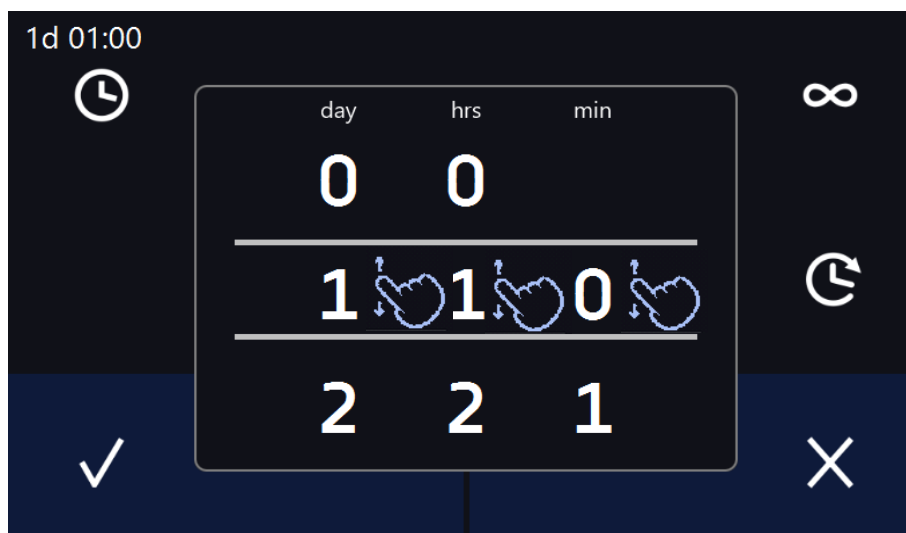

Figure 34 Quick change of the set time - setting the value



6.7.3. Quick change of fan efficiency and degree of air-flap opening



In order to quickly change the fan efficiency and/or degree of air-flap opening, press the icon  in the main screen (Figure 35). The value should be selected by scrolling the list up or down (Figure 36). Press  to confirm the change.

Figure 35 Quick change of fan efficiency and / or degree of air-flap opening - selection

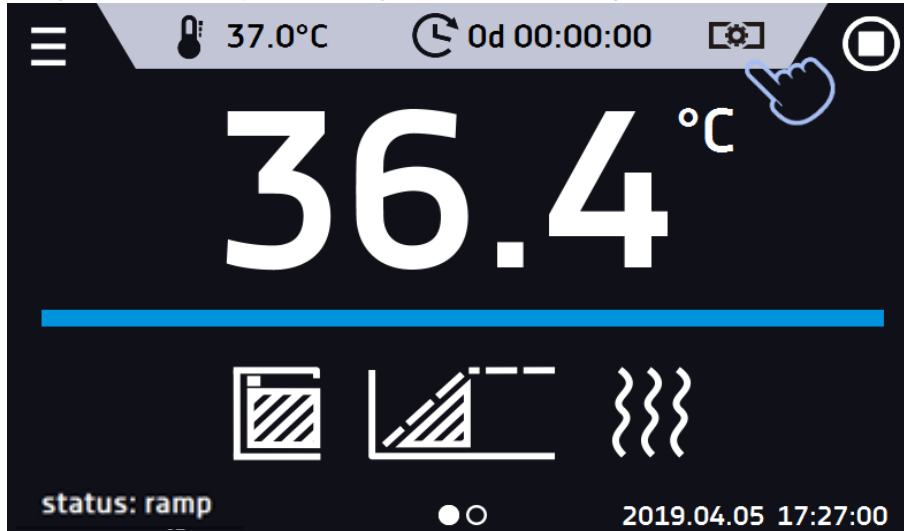
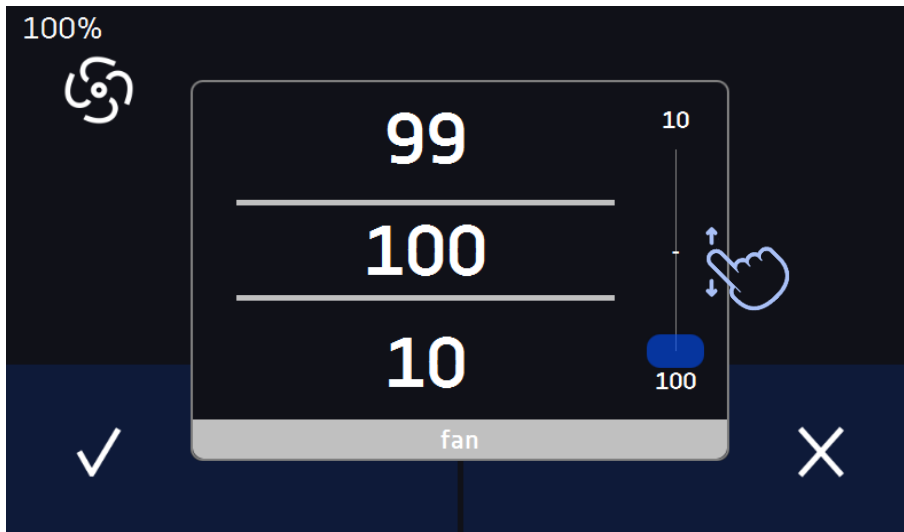



Figure 36 Quick change of fan efficiency and/or fireplace opening degree - value setting



6.8. Statistics

Go to the main menu  and press the icon . This panel (Figure 37) displays statistics of the currently running program or program that has ended. Statistics are calculated separately for each segment. Data logging for calculation starts after 30 seconds from reaching the set temperature in the segment. Further data is registered every 1 minute.

The following information is available:

- **set temperature [°C]** – set temperature in the segment,
- **minimum temperature [°C]** – the lowest recorded temperature,
- **maximum temperature [°C]** – the highest recorded temperature,
- **average temperature [°C]** – average temperature

- **segment** – status of the segment:
 - **in progress** – currently running segment (data is being constantly updated),
 - **finished** – the segment has been completed,
 - **interrupted** – the segment was interrupted by the user before the set time has elapsed,
- **segment 1/2** – the number of the currently overviewing segment / number of the currently performed or completed segment. Navigating between the segments is done by swiping your finger up or down.

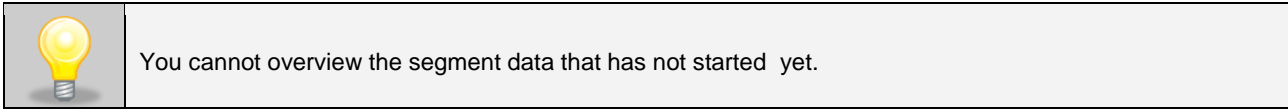
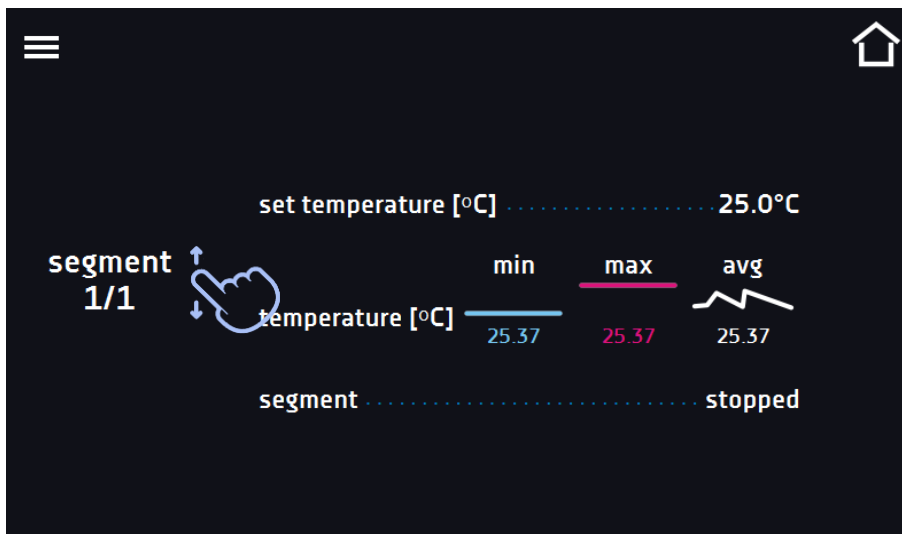



Figure 37 Statistics



6.9. Data record

Go to the main menu  and press the icon . Data record window (Figure 38) contains the following information:

- time and date of sample registration [date],
- temperature value measured with the main sensor in the chamber [temp.].

It is possible to register 10 000 data records for the max period of 6 months. If all the memory cells are full, the oldest ones are overwritten. The data appears in the table in the order they were added, not in chronological order by the date. The most recently added record is at the top. The samples are only registered when the program is running. The frequency of registration depends on the program parameters settings.

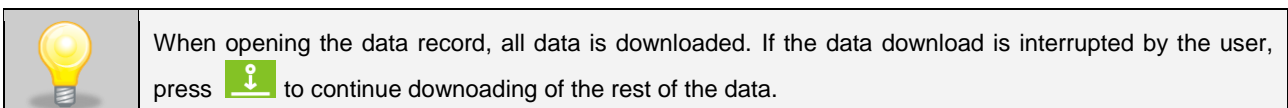

Figure 38 Data record

date	temp.	status
2020.11.11 09:13	24.65	set temp.
2020.11.11 09:12	24.65	set temp.
2020.11.11 09:11	24.65	set temp.
2020.11.11 09:10	24.65	set temp.
2020.11.11 09:09	24.65	set temp.
2020.11.11 09:08	24.65	ramp
2020.11.11 08:56	24.65	ramp
2020.11.11 08:46	24.65	ramp



Press to continue downloading data.



Recording data onto the USB flash drive. .csv files are available - separated by semicolon when opening e.g. with a spreadsheet, .plx - opening with the Lab Desk application (option)



Before removing the USB flash drive from the USB port, it must be unmounted, see [Section 5.9](#).



Deleting data

If there is a lot of data, a progress bar appears on the display ([Figure 39](#))

Figure 39 Progress bar

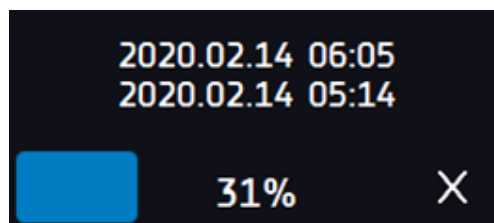
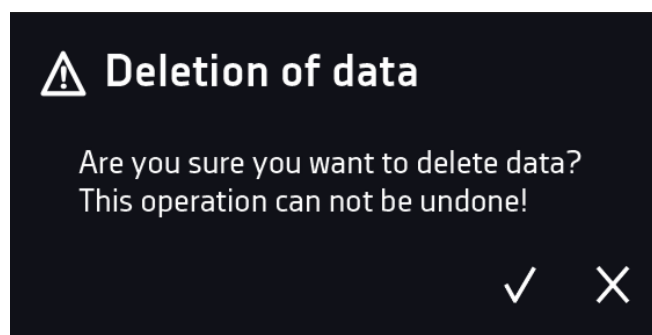

Figure 40 Deleting data



6.10. Event log



Go to the main menu  and press the icon . The window displays information about registered events, alarms and errors.

Figure 41 Event log



date	name	code
2020.11.10 21:04	Program Stop	2.01.0.1.008
2020.11.10 21:03	Program Start	2.01.0.1.007
2020.11.10 21:03	Program Stop	2.01.0.1.008
2020.11.10 21:03	Program Start	2.01.0.1.007
2020.11.10 21:03	Program Stop	2.01.0.1.008
2020.11.10 21:03	Program Start	2.01.0.1.007
2020.11.10 14:13	Program saved	2.01.0.1.022
2020.11.10 14:13	Program deleted	2.01.0.1.023
2020.11.10 14:12	Program updated	2.01.0.1.024

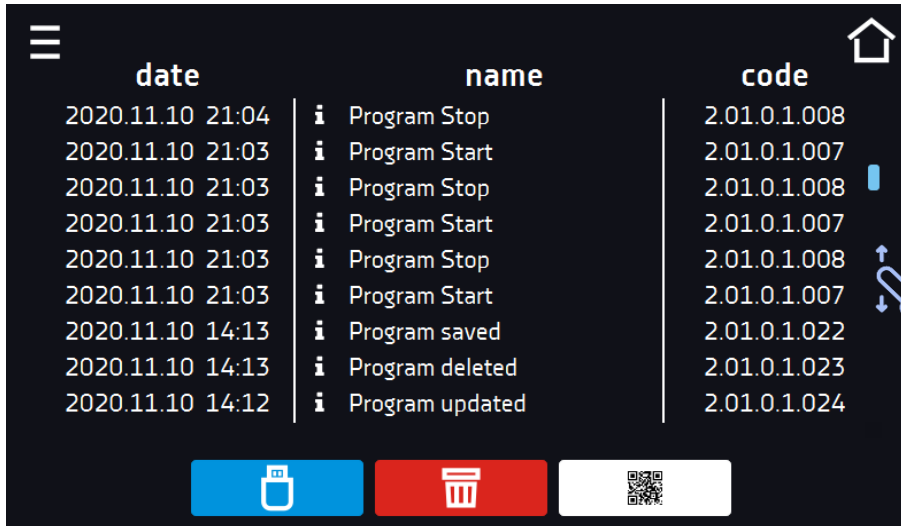

Recording data onto the USB flash drive. .csv files are available - separated by semicolon when opening e.g. with a spreadsheet, .plx - opening with the LabDesk application (option)



Before removing the USB flash drive from the USB port, it must be unmounted, see [Section 5.9](#).



Deleting data



QR code – opens smart4lab.eu (in the "Support" tab there are explanations of some of the information appearing in the event log). Press the symbol  and enlarge the code QR, and then scan it with your smartphone

Figure 42 QR code



The events in the event log are sorted chronologically. However, it may happen that the event "Program restarted" will not be displayed according to the chronology but the date and time of the event will be correct. This is not an error.

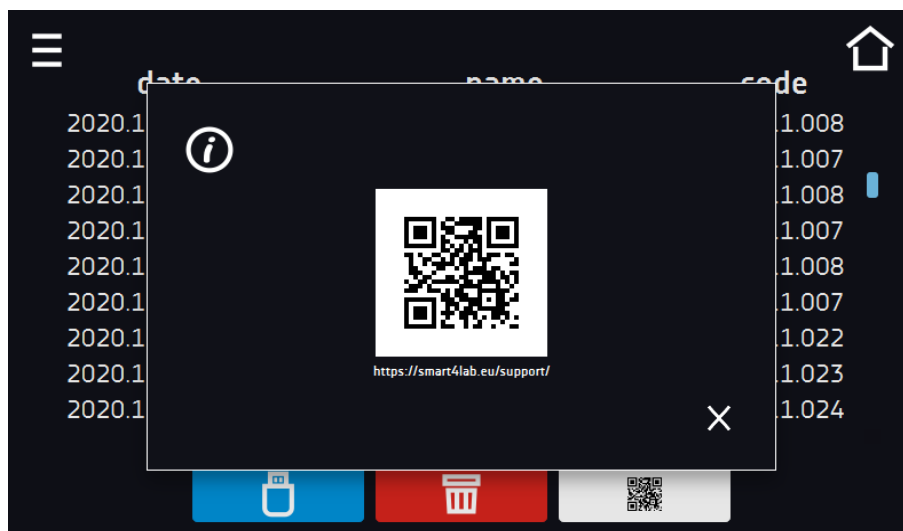

Before removing the USB flash drive from the USB port, it must be unmounted, see [Section 5.9](#).

Information signs in the event log:

-  Information event
-  Alarm event
-  Error
-  Warning

Possible events:

Program Start	starting the program
Program Stop	stopping the program
Program Edit	changing the program parameters
Program End	program is completed
DeviceOn	the device is switched on (on the main switch)
DeviceOff	the device is switched off (on the main switch)
Door opened	the door is opened
Open door alarm start	open door alarm has been activated
Door closed	the door is closed
Open door alarm stop	open door alarm has been deactivated
Program Restarted	program has been resumed after power failure
Under Protection Start	under-temperature protection has been activated
Under Protection Stop	under-temperature protection has been finished
Upper temp. alarm Start	over- temperature protection has been activated
Upper temp. alarm End	over- temperature protection has been deactivated
Date/time change	date/time has been changed
Lower temp. alarm Start	activation of the alarm of exceeding the temperature below the set temperature
Lower temp. alarm End	deactivation of the alarm of exceeding the temperature below the set temperature
Upper temp. alarm Start	activation of the alarm of exceeding the temperature above the set temperature
Upper temp. alarm End	deactivation of the alarm of exceeding the temperature above the set temperature
Program saved	new program has been saved
Program deleted	program has been deleted
Program updated	program has been updated
Time Zone Changed	in the time settings the time zone has been changed
Temperature Correction Changed	main sensor temperature correction has been changed
Emergency stop of the program	the program has been automatically stopped – there was a situation that didn't allow the program to be continued. PLEASE CONTACT THE SERVICE
Start program cancelled, door is open	the program has not been started due to the door open, it only applies to running the predefined programs in SR sterilizers

Program aborted, door was opened	program stopped due to door opening, only applies to the predefined programs in SR sterilizers
Power Fail Start	power failure / device fuse blown out.
Power Fail Stop	power resumed, returned to maintain program parameters

6.11. Info



Go to the main menu  and press the icon . The panel contains the following information:

- name of device,
- device's temperature range
- serial number of the device
- Software version,
- manufacturer's address,
- manufacturer's website,
- QR code.

Figure 43 Info window (example)



* lower operating temperature limit is not lower than 5°C above ambient temperature (applies to CL / SL / SR / SRWP devices)



Press icon  to save the “Download” folder (with instruction manual) on the USB flash drive. After inserting the flash drive into USB port wait few seconds until the information “Flashdrive connected” will appear on the display. Press the icon  to write the service data on the USB flash drive – contact the service department for more information.

Press  to go to the main screen.



Before removing the USB flash drive from the USB port, it must be unmounted, see [Section 5.9](#).

6.12. User settings panel

Go to the main menu  and press the icon . In this panel ([Figure 44](#)) you can:





	Change the name of the equipment – by default, the device serial number is entered.
	Change the language in the equipment's menu.
	Set the time after which the screen will be dimmed.
	Turn on/off the sound . Critical alarms will continue emitting a sound.
	Set the time after which the user will return to the home screen. Available settings: off, 1 min, 3 min, 5 min, 10 min.
	Set the automatic screen lock. Available settings: off, 5 min, 15 min, 30 min, 60 min. Factory setting: disabled.

Figure 44 User settings panel 

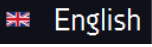

Confirms changes



Cancel the entered changes



6.12.1. **Unlocking the touch screen**

When the automatic touch screen lock is enabled ([Section 6.16](#)), slide the blue circle into the white circle to unlock the screen.

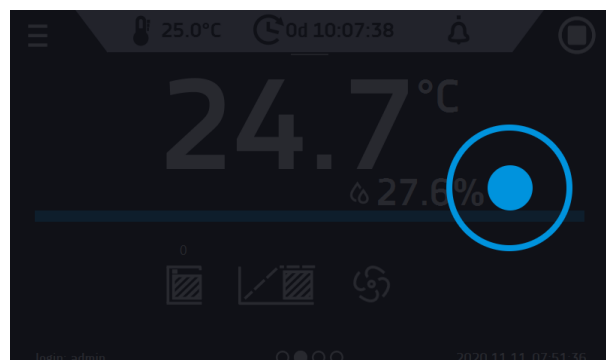
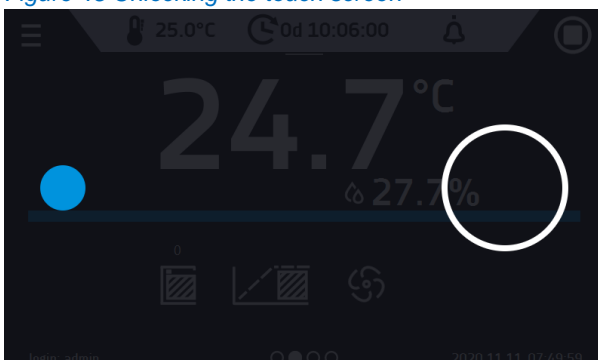
Figure 45 Unlocking the touch screen



6.13. Time

Go to the main menu  and press the icon . In this panel you can:

- change the date / system time



If the date / system time is changed to the later date / time comparing with the data and events which are stored in the memory, they will remain in the register. If the date / system time is changed to the earlier date than the date / time which is stored in the memory, they will be transferred to the archive

After changing the date / system time the device will be restarted.

- change time zone - the change of time zone will not affect the date / time in data and events previously saved.

To change the date / system time it is necessary to press  in the window (Figure 46). The window will appear and you will be able to make changes (Figure 45).

Figure 46 Time zone change



Confirms changes and restarts the device

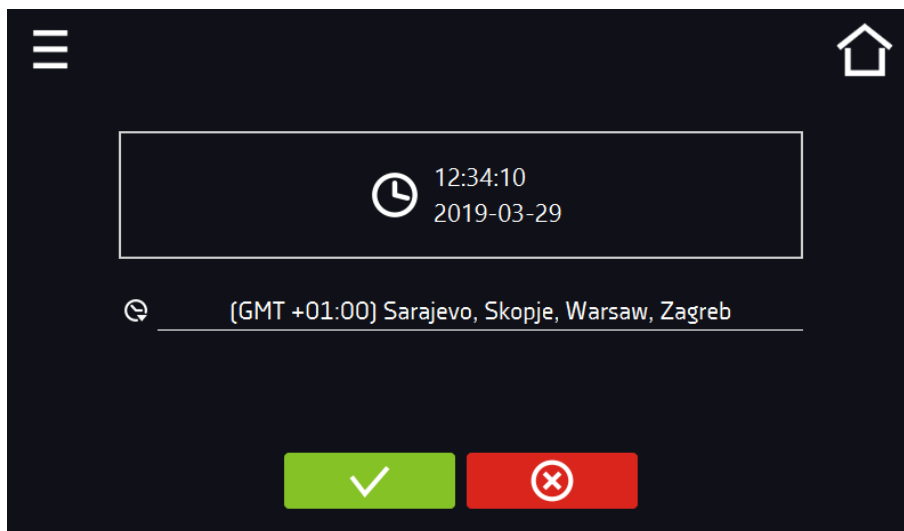

Cancel the entered changes

Figure 47 Date / time change



6.14. Alarms

6.14.1. Alarms when set parameters are exceeded

Press the main menu icon , and then press . Here you can set parameters related to alarms

- **low alarm** – an alarm will be generated if the temperature drops below the set value by the value specified in this field,
- **high alarm** – an alarm will be generated if the temperature increases above the set value by the value specified in this field.

 In the "lower alarm" field you can enter a value from the range of -0.5°C to -5°C, and in the "upper alarm" field from the range of 0.5°C to 5°C.

Figure 48. Parameter exceedance alarms



Confirm the changes.

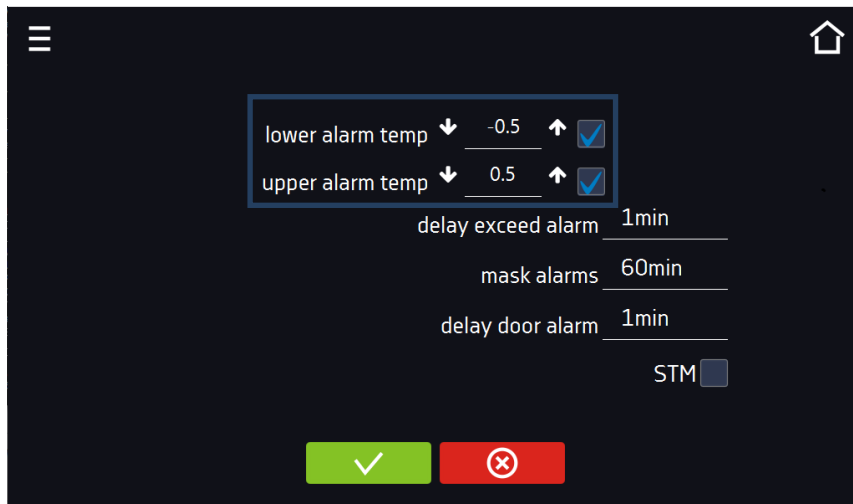

Cancel the entered changes.

The upper and lower alarms can only be generated when the set temperature is reached.

- **temperature alarm delay:**
the alarm will be activated with a delay (1 min, 2 min, 5 min, 10 min, 15 min) after exceeding the permitted temperature.

6.14.1.1. Masking of parameter exceedance alarms

Masking of alarms when the set parameters are exceeded can be used when new samples are added to the chamber or samples are added to those already incubated. During these activities, the set parameters, i.e. temperature, may be exceeded and alarms may be activated - parameter exceedance alarms are set assuming that stable conditions prevail in the chamber (temperature) and the door is closed. After opening the door and placing the samples in the chamber, time is needed for the parameters to stabilize - the alarm masking function allows you to delay alarms when the parameters are exceeded.

The parameter exceedance alarm will be triggered with a delay (15 min, 30 min, 45 min, 60 min, 120 min, 150 min, 180 min) after inserting new samples. The time is counted from the last time the door was opened. Setting 0 s means masking is disabled.



If the door is opened during the parameter exceedance alarm, the ongoing alarm will not be "masked". Only the next alarm can be masked.

Figure 49. Alarm masking

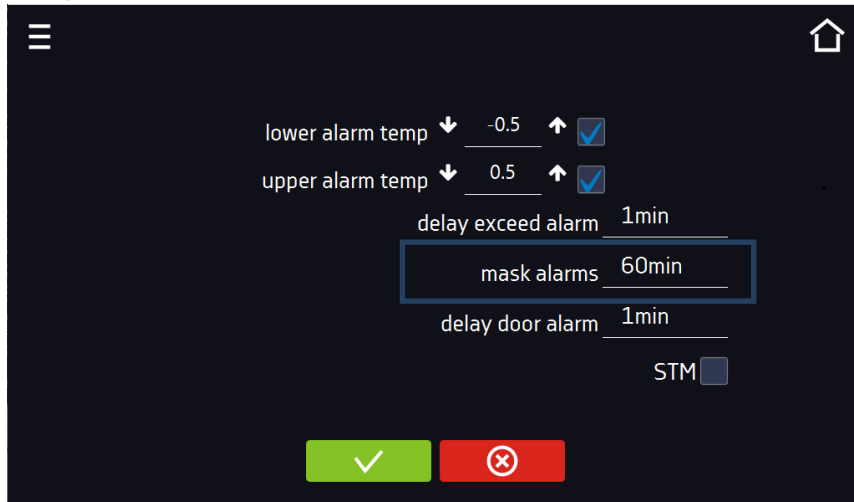

Confirm the changes.



Cancel the entered changes.

Figure 50 Alarm masking enabled

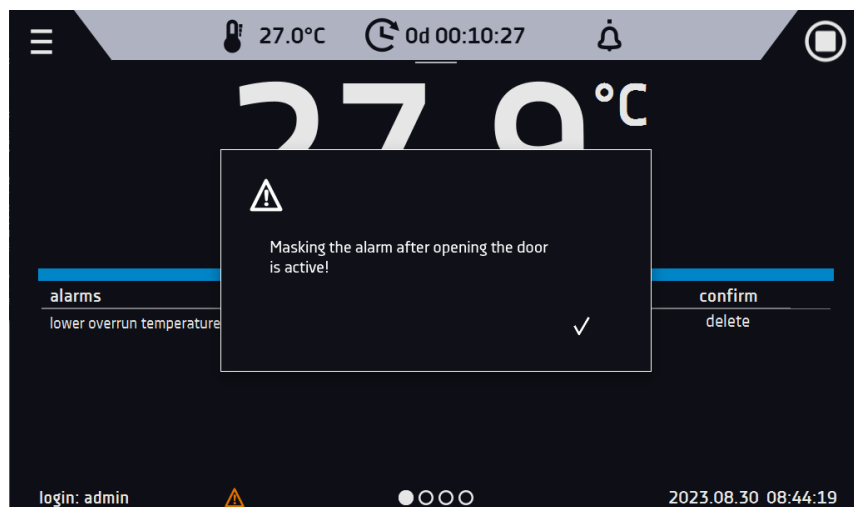

6.14.2. Open door alarm

All devices are equipped with an open door sensor. If the door is left open longer than the time set by the user, an acoustic signal, a red flashing alarm bar and a "door open" alarm with the status "active" will appear.

- **door open alarm delay:**
The door alarm will sound when the door is open for the user-selected time (30 sec, 1 min, 2 min, 5 min, 10 min).

Figure 51. Open door alarm delay

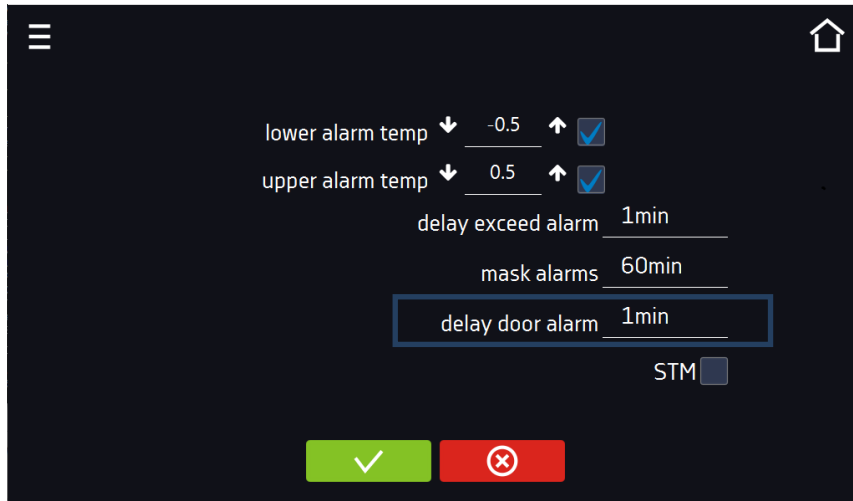

Confirm the changes.



Cancel the entered changes.

6.14.3. STM function

The STM (Smart Temperature Monitor) function informs the user if there is a problem in reaching or maintaining the set temperature. The user can enable/disable the function (Fig.70).

If the STM function is enabled, the STM symbol will appear on the screen next to the temperature of the main sensor.

Figure 52. Enable/disable STM function

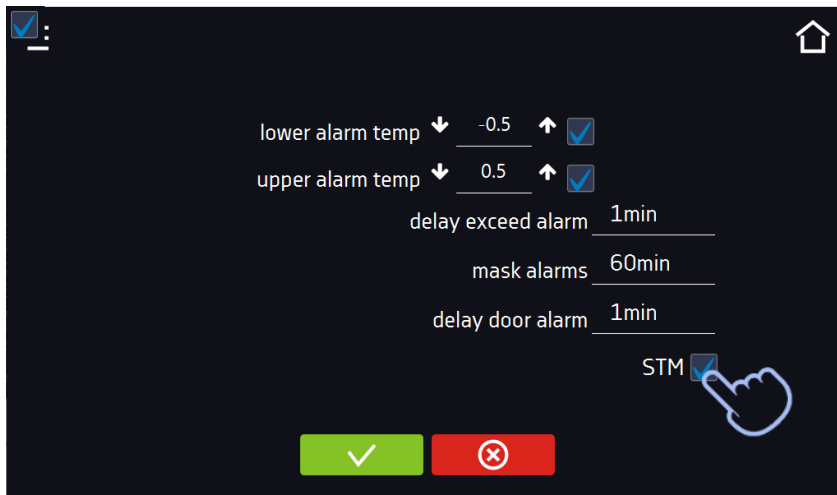

Confirm the changes.



Cancel the entered changes.

The function status is indicated by color:

- no inscription – option disabled,
- white color – option enabled, program is stopped (Fig. 71),
- blue color – option enabled (temperature monitoring), program running (Fig. 72),
- red color – option enabled, warning about problems with achieving/maintaining temperature (Fig. 73).

Figure 53.



Figure 54.



Figure 55.



Possible causes of operation:

1. damaged heater,
2. the cartridge inserted into the chamber absorbs / releases too much energy.

If the color was red before opening the door, then the color changes to blue after opening the door.

If the function is activated (detection of problems with achieving/maintaining temperature):

- the warning 4.00.0.1.009... appears in the event log.
- the color of the STM inscription changes to red and remains red throughout the disruption, segment change, and program shutdown.
- when the state changes from red to blue, an entry about the end of function 4.00.0.1.010 appears in the event log.

6.14.4. Mute option

The icon  in the main screen in the upper menu allows temporary switching off of the alarms sound (open door alarm, exceeding temperature range), e.g. to avoid door alarm during planned loading of the samples into the chamber. There are options to turn off the sound for 5, 10 and 15 minutes ([Figure 56](#)), however, the sounds of critical alarms (e.g. damage to the temperature sensor, over- and under-temperature protection) will be still emitted.

Figure 56 Setting the time of mute function



6.15. Network

Go to the main menu  and press the icon . In this panel ([Figure 57](#)) you can change LAN settings:

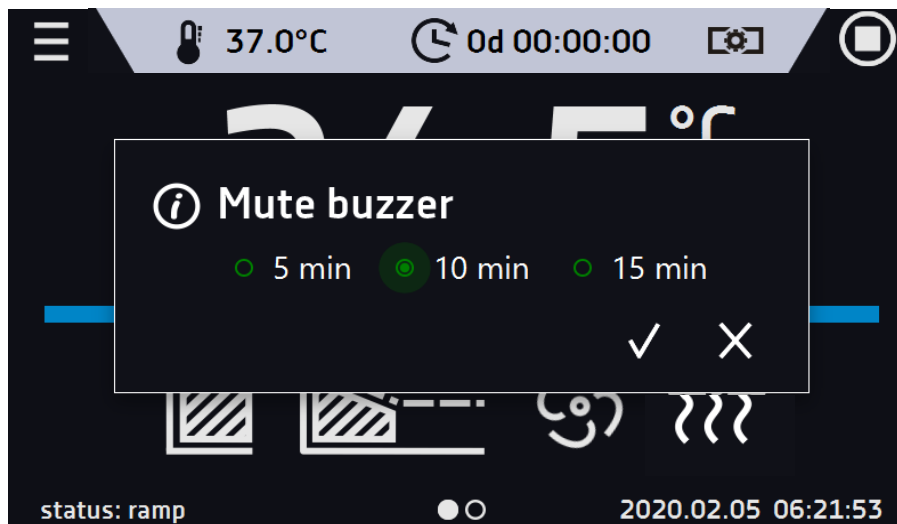
- **IP** – the device's IP address
- **Mask** – an Ethernet network mask to which the device is connected
- **Gate** – Server's IP address or router's that manages the Ethernet network
- **DNS** – IP address of the domain name system
- **MAC** – the address of the network card, read-only
- **DHCP** – you can select if the server that allocates IP addresses is running on the local network. You can then skip setting IP, Masks, Gates

Icon  indicates the connection status:



Device connected to the network



Device disconnected from the network

Figure 57 – LAN settings

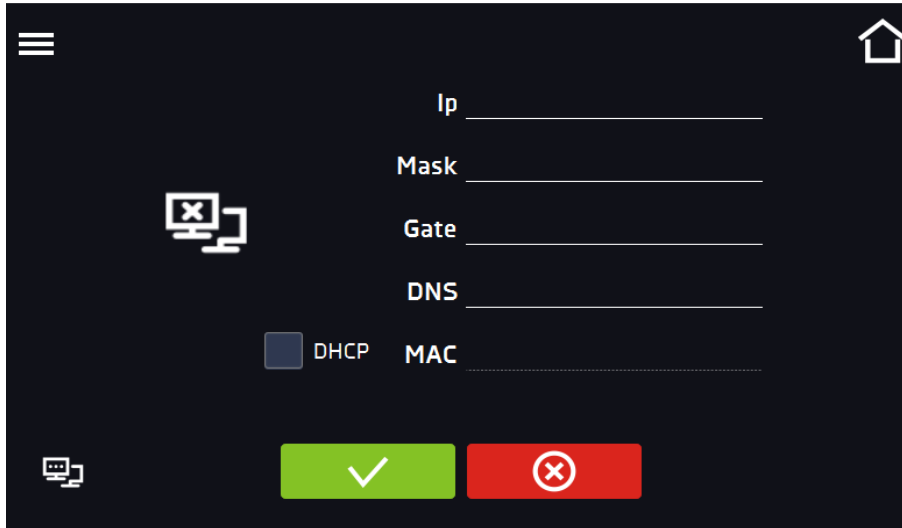



Confirms changes



Cancels the entered changes

6.16. Corrections

Go to the main menu  and press the icon . In this window (Figure 58) you can correct temperature value indicated on the display by adding the correction value. The set correction value applies to the whole temperature range of the device. For example, if the average temperature displayed by the device indicates 40,0°C and the average temperature measured by independent, external sensor indicates 40,5°C, the correction should be set on +0,5°C. The average temperature should be calculated from chosen period of time e.g. 30 min. The correction available range is between -5°C to +5°C.



The device has been calibrated by the manufacturer in accordance with applicable norms. The temperature shown on the display corresponds with a great accuracy to the temperature near chamber's sensor. For the correct operation of the device it is not necessary to use user's calibration. The user is performing temperature correction **on his own responsibility** and must be aware of consequences of changing manufacturer's settings. If the equipment was calibrated, calibration certificate **loses its validity**.

Figure 58 User's correction

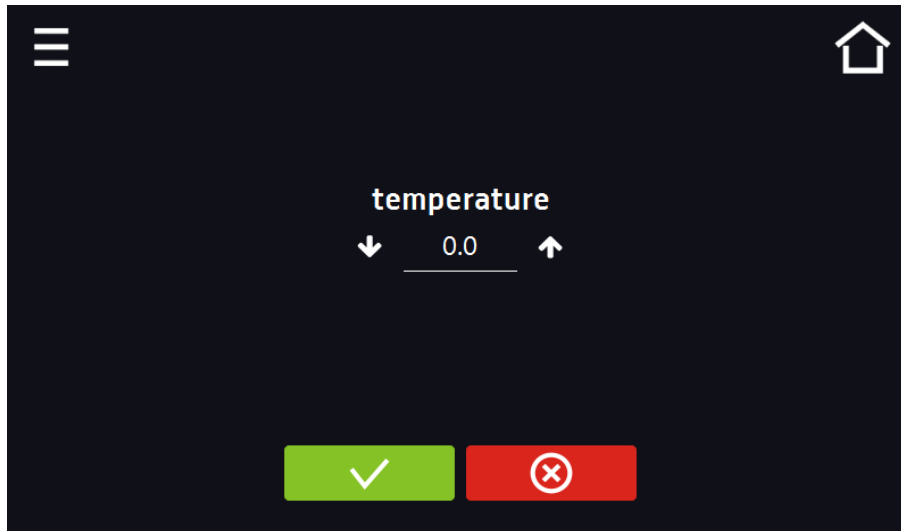

Confirms changes



Cancel the entered changes

7. INTERFACE

7.1. MODBUS TCP

The device allows status monitoring using the MODBUS TCP communication interface.

Connection parameters:

- IP address: same as device's (set in the panel [Section 6.15.](#))
- port: 502

register INPUT REGISTERS			
function READ_INPUT_REGISTERS (0x30001)			
Address	Type	Multiplier	Description
0	int	10	temperature from the main sensor
3	bool	-	Open door
4	bit	-	b0 – door alarm b1 – upper temperature alarm b2 – lower temperature alarm b3 – over Protection b5 – main sensor error b7 – protection sensor error b8 – temperature sensors error b10 – hardware error b11 – MRW error

8. TEMPERATURE PROTECTION

The device is factory fitted with sample protection - temperature protection. If any of the elements responsible for maintaining the set temperature is damaged or the user sets the temperature unconsciously, the set protection will work.

8.1. Temperature protection class in CL, SL, SR, SRWP models

Standard equipment in the CL, SL, SR and SRWP devices is protection class 2.0 according to DIN 12880.

Optionally, the devices can be equipped with protection class 3.1 according to DIN 12880. Then the user can program the temperature value of the upper protection. When the set temperature is exceeded, the heating system power will be turned off. When the temperature returns to the allowed range, the device will resume operation.

The figure below shows how this works.

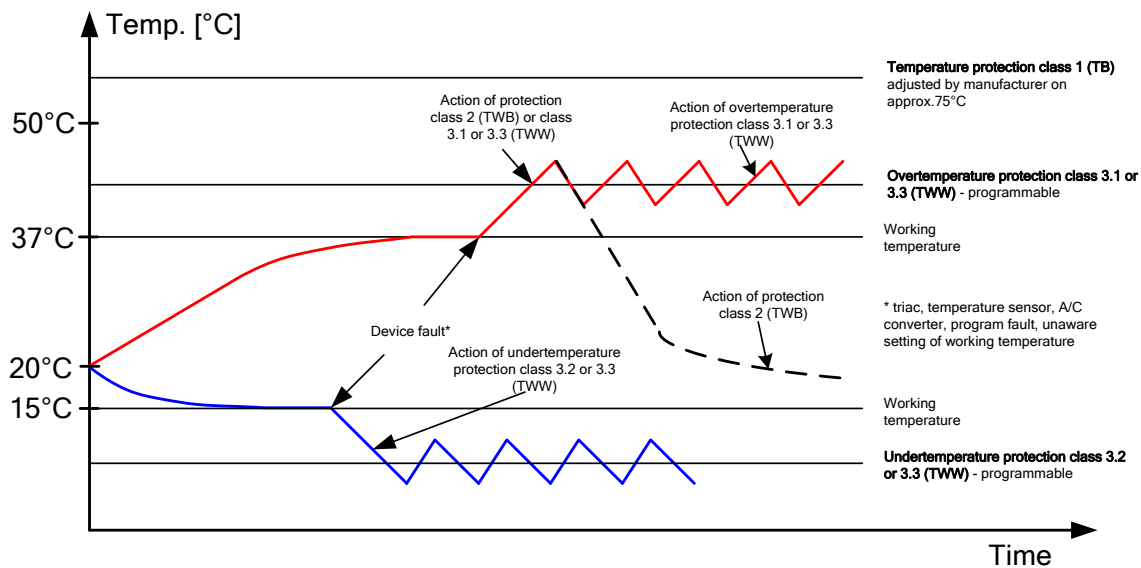

9. SLWN DRYING OVENS WITH NITROGEN BLOW

According to the requirements of the **PN-ISO 589:2006** norm which refers to the determination of total moisture in hard coal requires that coal, the samples susceptible to oxidation should be dried at a temperature of + 105°C in a drying oven with a nitrogen flow. Requirements for the use of the equipment are given in point 6 of the norm. A drying oven with nitrogen flow should be used to control the temperature in the range of + 105°C to + 110°C with the additional possibility of blowing with a stream of dry nitrogen at a flow rate of about 15 volumes of the drying oven per hour.

Drying ovens with nitrogen blow are available in two versions:

1. **SLWN1** – laboratory oven with dry nitrogen blow system of the chamber; the kit includes connections, valves and a laboratory rotameter which can be calibrated
2. **SLWN2** – laboratory oven with dry nitrogen blow system of the chamber; the kit includes connections, valves and a tech rotameter which can't be calibrated

The nitrogen cylinder is not included in the kit.

	SLWN drying ovens can work only in well ventilated rooms.
--	--

9.1. Description of the kit

Depending on the model, the drying oven may be equipped with one of the following nitrogen connection kits:

Kit A for SLWN2 (with tech rotameter which can't be calibrated)

The kit includes:

1. two-stage cylinder reducer with a rotameter for technical gases
2. connection hose 2 m long
3. inox hose clamps 2 pcs.



1. inlet pressure gauge (high pressure)
2. connector to connect to the cylinder
3. technical rotameter
4. shut-off valve knob
5. end for the hose connection

Kit B for SLWN1 (with laboratory rotameter which can be calibrated)

The kit includes:

1. one-stage cylinder reducer
2. laboratory rotameter
3. connection hose 4 m long
4. inox hose clamps 4 pcs.

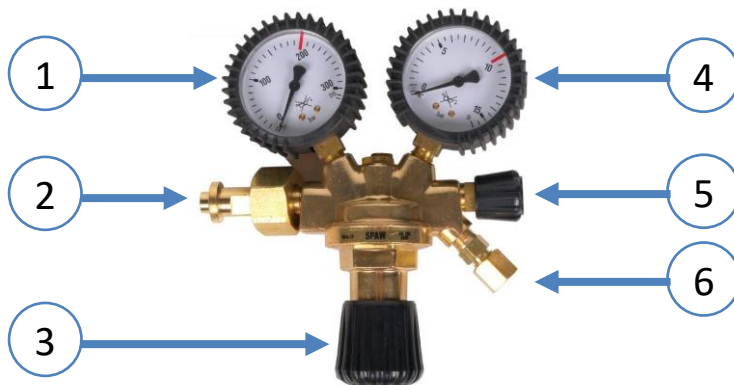

1. inlet pressure gauge (high pressure)
2. connector to connect to the cylinder
3. pressure adjustment screw
4. outlet pressure gauge (low working pressure)
5. shut-off valve
6. end for the hose connection

Reducer

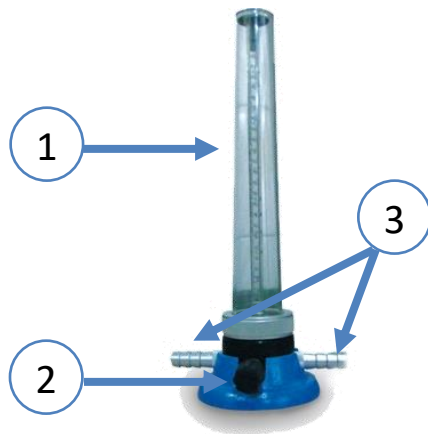

Laboratory rotameter

1. scale of the pressure gauge
2. flow control valve knob
3. end for the hose connection

Kit C for SLWN2 (with tech rotameter which can't be calibrated)

The kit includes:

1. one stage cylinder reducer
2. technical rotameter
3. connection hose 4 m long
4. inox hose clamps 4 pcs.

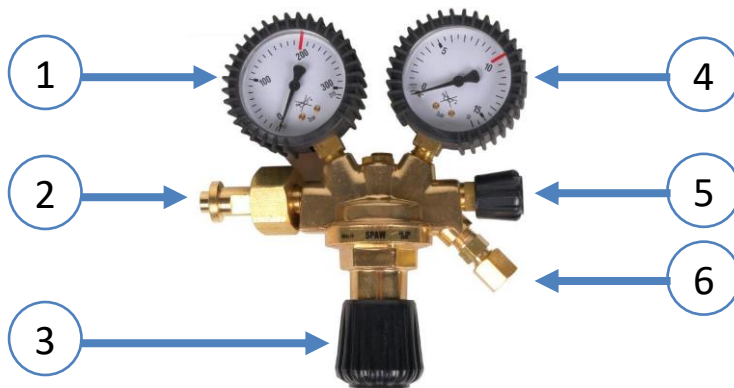

Reducer

1. inlet pressure gauge (high pressure)
2. connector to connect to the cylinder
3. pressure adjustment screw
4. outlet pressure gauge (low working pressure)
5. shut-off valve
6. end for the hose connection

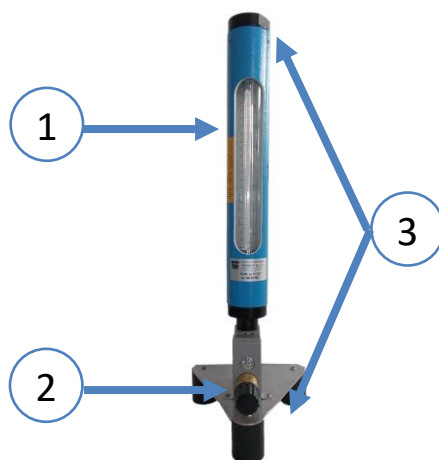

Technical rotameter

1. scale of the pressure gauge
2. flow control valve knob
3. end for the hose connection

9.2. Connection

Before using:

- check carefully the condition of the reducer, especially the inlet fitting, connecting nut, pressure gauge, rotameter and safety valves,
- check the condition of the valve on the cylinder and then, standing on the side of the outlet nozzle, blow the valve by opening it temporarily,
- in the event of impurities of the valve, reducer or connector in the equipment, clean and degrease these places, and replace damaged gaskets with a new ones.

9.2.1. Connection of the Kit A

In order to connect the Kit A you have to:

1. Connect the reducer with the rotameter to the cylinder valve.
2. After connecting the reducer to the cylinder valve, slowly open the valve and with the closed shut-off valve at the reducer outlet, check the tightness of the cylinder valve, its connection with the reducer, sealing of the 1st and 2nd stage reduction systems, safety valves and shut-off valve by lubricating with soapy water. A sign of leakage of the 1st stage reduction system may be an increase in the intermediate pressure above the allowable pressure, causing the opening of the safety valve for this pressure. Similarly: a symptom of leakage of the 2nd stage reduction system may be a pressure increase causing the opening of the pressure safety valve at the outlet.
3. Attach a rubber hose to the end and put the hose clamp on and tighten it. To facilitate insertion, you can temporarily put the hose in hot water or lubricate the end with soapy water. The rubber hose should have an internal diameter in accordance with the technical data of the reducer and should be able to withstand the maximum outlet pressure. Hoses should be in good condition and can't be contaminated. New hoses should be blown out.
4. Put the other end of the hose onto the connector of the equipment (located at the bottom back of the drying oven). Put the hose clamp on and tighten it.
5. After connecting the hose to the ends of the reducer and the equipment, open the shut-off valve on the reducer and check by lubricating with soapy water the tightness of the hose, its connections to the reducer and to the equipment.

The connection method is shown in the figure below.

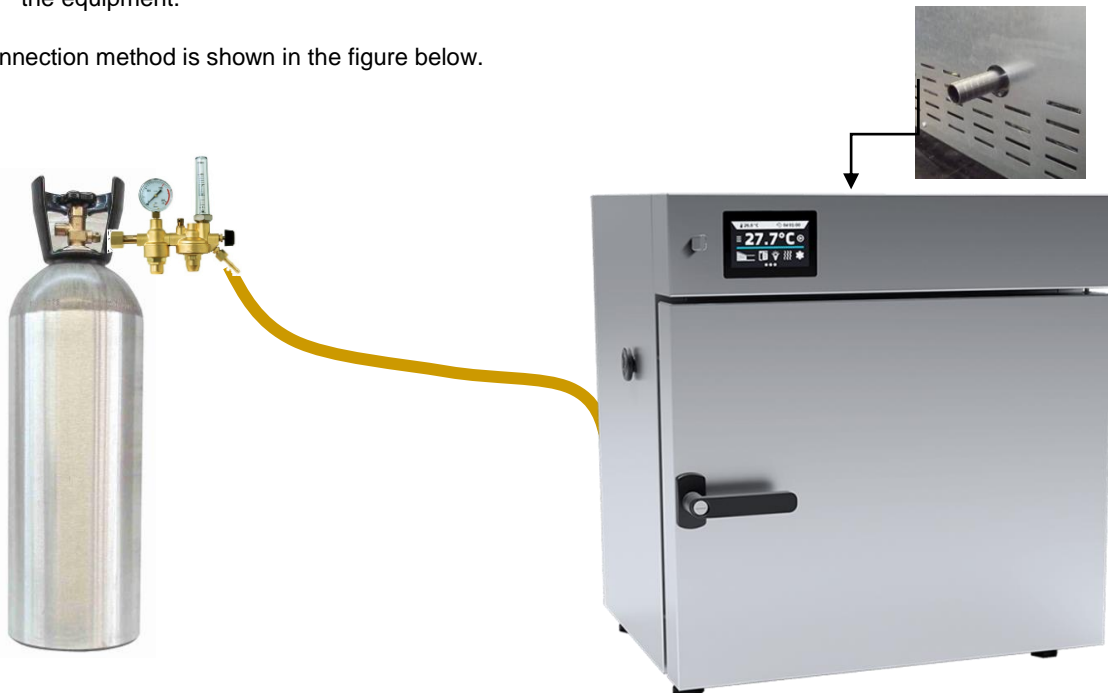

9.2.2. Connection of the Kit B

In order to connect the Kit B you have to:

1. The supplied hose cut into two parts, the length should be chosen so it will be possible to connect the cylinder with the rotameter and the rotameter with the equipment.
2. Connect the reducer to the cylinder valve. Attach a rubber hose to the end and put the hose clamp on and tighten it. To facilitate insertion, you can temporarily put the hose in hot water or lubricate the end with soapy water. The rubber hose should have an internal diameter in accordance with the technical data of the reducer and should be able to withstand the maximum outlet pressure. Hoses should be in good condition and can't be contaminated. New hoses should be blown out.
3. Put the other end of the hose onto the connector of the rotameter (pay the attention to the flow direction marked on the basis of a rotameter). Put the hose clamp on and tighten it.
4. Place the end of the second part of the hose on the connector in the rotameter. Put the hose clamp on and tighten it.
5. Insert the other end of the second part of the hose onto the connector of the equipment (located at the bottom back of the drying oven). Put the hose clamp on and tighten it.
6. After connecting the hose to the ends of the reducer and the equipment, open the shut-off valve on the reducer and check by lubricating with soapy water the tightness of the hose, its connections to the reducer and to the equipment.

The connection method is shown in the figure below.

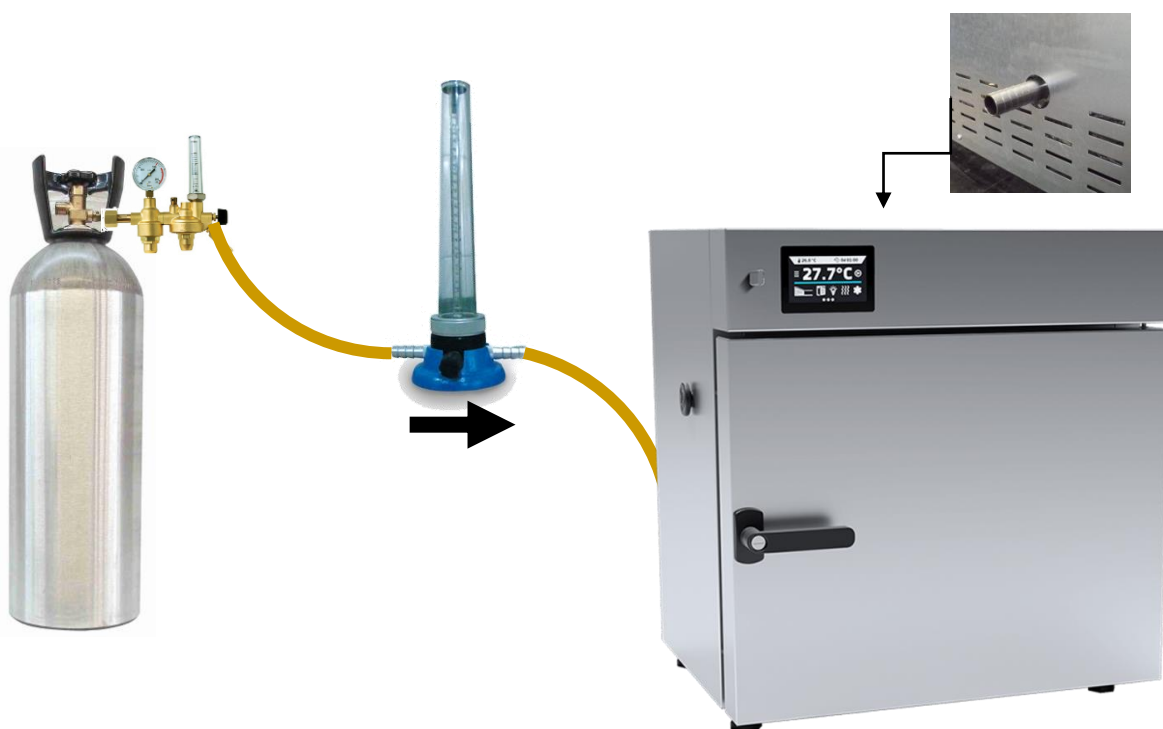

9.2.3. Connection of the Kit C

In order to connect the Kit C you have to:

1. The supplied hose cut into two parts, the length should be chosen so it will be possible to connect the cylinder with the rotameter and the rotameter with the equipment.
2. Connect the reducer to the cylinder valve. Attach a rubber hose to the end and put the hose clamp on and tighten it. To facilitate insertion, you can temporarily put the hose in hot water or lubricate the end with soapy water. The rubber hose should have an internal diameter in accordance with the technical data of the reducer and should be able to withstand the maximum outlet pressure. Hoses should be in good condition and can't be contaminated. New hoses should be blown out.
3. Put the other end of the hose onto the connector of the rotameter (pay the attention to the flow direction marked on the basis of a rotameter). Put the hose clamp on and tighten it.
4. Place the end of the second part of the hose on the connector in the rotameter. Put the hose clamp on and tighten it.
5. Insert the other end of the second part of the hose onto the connector of the equipment (located at the bottom back of the drying oven). Put the hose clamp on and tighten it.
6. After connecting the hose to the ends of the reducer and the equipment, open the shut-off valve on the reducer and check by lubricating with soapy water the tightness of the hose, its connections to the reducer and to the equipment.

The connection method is shown in the figure below.

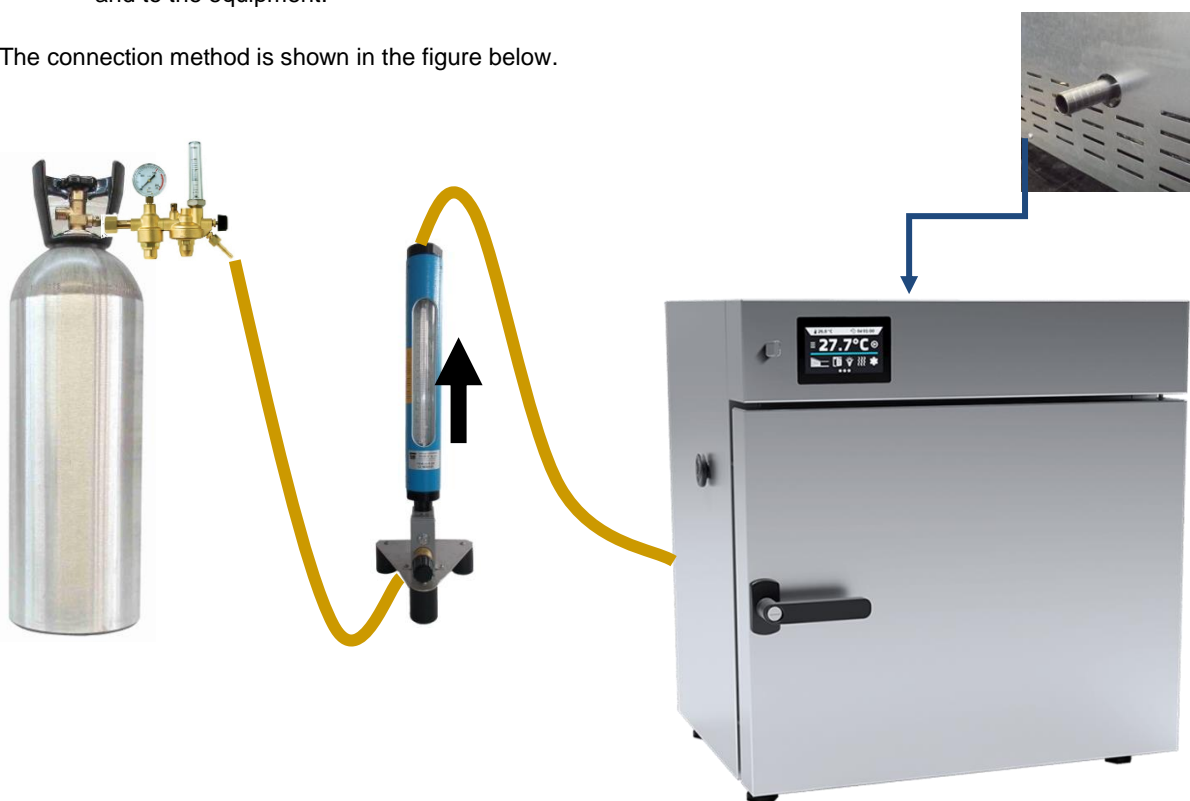

9.3. Shut-off solenoid valve for gas supply (optionally)

The solenoid valve opens the gas supply to the equipment at the beginning of the program and closes it when the program is finished. If the program has been started with a delay, while waiting for the start of the first segment of the program, the gas supply is closed.

The connection is made through rubber hose connector with an external thread 1/4 (or 1/8 depending on the solenoid valve). The flow direction is indicated by an arrow symbol. To the output of the solenoid valve we connect the input to the equipment, and to the input-output of the rotameter.



9.4. Operation and maintenance of the dry nitrogen blow system

The nitrogen flow rate should be calculated according to the methodology given in [Section 9.5](#).

Before starting to work with the drying oven with dry nitrogen blow, set the correct pressure and flow as described below.

Kit A

Open the cylinder valve slowly and constantly observing the indications on the rotameter, adjust the valve knob on the reducer until the required flow rate is achieved.

Kit B and C



Do not set a pressure higher than 4 bar on the low-pressure working gauge with the adjustment screw. It can damage the rotameter.

1. Close the control valve on the rotameter (turning clockwise).
2. Set the minimum pressure on the reducer with the adjustment screw (turning left).
3. Close the shut-off valve (if applicable) on the reducer.
4. Slowly open the cylinder valve.
5. Using the adjustment screw on the reducer, set the pressure of 3 bar on the low-pressure working gauge.
6. After correctly set pressure on the reducer, unscrew the shut-off valve (if applicable).
7. Adjust the valve on the rotameter until the required flow is achieved.

During long-term breaks in use, close the cylinder valve.

During operation, check the tightness of the reducer and its connections once at month, using soapy water.

If the reducers operate at low temperatures, they can freeze from the inside. Frozen reducers should be thawed with hot water or steam. You can also use electric or water heaters on permanent basis.

9.5. Methodology for calculating the nitrogen flow rate in the drying oven

Calculation of nitrogen flow rate in drying ovens intended for drying oxidizing coals.

Depending on the capacity of the drying oven, calculate the flow rate (set on the rotameter). An example of how to calculate the flow rate for the SLWN 115 STD at the temperature of 105°C is given below.

Description of variables:

V_k	- total capacity of the chamber	
	SLWN 15:	$V_k = 28,6 \text{ l} = 0.0286 \text{ [m}^3\text{]}$
	SLWN 32:	$V_k = 50 \text{ l} = 0.0500 \text{ [m}^3\text{]}$
	SLWN 53:	$V_k = 83 \text{ l} = 0.0830 \text{ [m}^3\text{]}$
	SLWN 115:	$V_k = 152 \text{ l} = 0.1520 \text{ [m}^3\text{]}$
	SLWN 180:	$V_k = 180 \text{ l} = 0.180 \text{ [m}^3\text{]}$
	SLWN 240:	$V_k = 314 \text{ l} = 0.3140 \text{ [m}^3\text{]}$
	SLWN 400:	$V_k = 543 \text{ l} = 0.5430 \text{ [m}^3\text{]}$
	SLWN 750:	$V_k = 935 \text{ l} = 0.9350 \text{ [m}^3\text{]}$
	SLWN 1000:	$V_k = 1200 \text{ l} = 1.200 \text{ [m}^3\text{]}$
Q_h	- required flow per hour [l/h]	
Q_{ma}	- required flow per minute for atmospheric pressure [l/min]	
Q_{mr}	- required flow per minute for reduced pressure [l/min]	
V_r	- gas volume on the rotameter [m ³]	
p_r	- gas pressure on the rotameter [bar]	
p_k	- pressure in the chamber (atmospheric) [bar]	

Calculations:

required gas flow per hour:

$$Q_h = V_k * 15 \text{ [l/h]}$$

required gas flow per minute for atmospheric pressure:

$$Q_{ma} = \frac{Q_h}{60} = \frac{V_k * 15}{60}$$

For e.g. SLWN 115 $V_k = 152$ [l]

$$Q_{ma} = \frac{152 * 15}{60} = 38 \text{ [l/min]}$$

NOTE: (applies to RUG rotameters, which are accessories of a two-stage cylinder reducer with a rotameter type 2RBAz-0,3R):

If there are „dm³/min N₂ / T = 293 K / P = 392,3 kPa / T₀ = 273 K / P₀ = 101,3 kPa” markings next to the scale on the rotameter, the result obtained in the calculations should be divided by the correction factor $k_v = 1.14$.

The correction factor should be taken into account because the rotameter is scaled in normal liters for 3.923 [bar] working pressure, and the reducer works at a pressure of 3 [bar].

$$Q_{mr} = \frac{Q_{ma}}{1,14} = \frac{38}{1,14} = 33,33 \text{ [l/min]}$$

If the change in gas volume is taken into account with the increase of its temperature in the chamber, then the ideal gas equation should be used (assuming constant pressure during heating):

$$\frac{p_k * V_k}{T_k} = \frac{p_r * V_r}{T_r}$$

Instruction manual CL, SL, SLWN, SR, SRWP SMART

where:

$$T_r - \text{gas temperature on the rotameter: } T_r = 273,15 + t_r = 273,15 + 25 = 298,15 \text{ [K]}$$

$$T_k - \text{gas temperature in the chamber, in this case } t_k = 105^\circ\text{C: } T_k = 273,15 + t_k = 273,15 + 105 = 378,15 \text{ [K]}$$

Calculation for the temperature in the chamber $t_k = 105 \text{ [}^\circ\text{C]}$:

$$\frac{1 * V_k}{378,15} = \frac{1 * V_r}{298,15}$$

$$V_r = 0,79 * V_k$$

analogously:

$$Q_{mr} = 0,79 * Q_{ma} \text{ [l/min]}$$

For e.g. SLW 115 the result was:

$$Q_{mr} = 0,79 * 38 = 30,02 \text{ [l/min]}$$

For reducers with inbuilt RUG rotameters taking into account correction factor:

$$Q_{mr} = 0,79 * 33,33 = 26,33 \text{ [l/min]}$$

Data for each equipment.

Required flows for the temperature in the chamber $t_k = 105 \text{ [}^\circ\text{C]}$:

Equipment	Q_h [l/h]	Q_{mr} [l/min]
SLWN 15	338,91	5,65
SLWN 32	592,50	9,88
SLWN 53	983,55	16,39
SLWN 115	1801,20	30,02
SLWN 180	2891,40	48,19
SLWN 240	3720,90	62,02
SLWN 400	6434,55	107,24
SLWN 750	11079,75	184,66
SLWN 1000	14220,00	237,00

Required flows for the temperature in the chamber $t_k = 105 \text{ [}^\circ\text{C]}$ and for reducers with inbuilt RUG rotameters taking into account correction factor $k_v = 1,14$:

Equipment	Q_{mr} [l/min]
SLWN 15	4,95
SLWN 32	8,66
SLWN 53	14,38
SLWN 115	26,33
SLWN 180	42,27
SLWN 240	54,40
SLWN 400	94,07
SLWN 750	161,98
SLWN 1000	207,89



NOTE: the above calculations refer to the empty chamber of the drying oven. In laboratory conditions, the total volume of the chamber V_k should be corrected by the volume of dried material. Depending on the capacity of a drying oven, the calculations should be modified accordingly.

10. SRWP PASS-THROUGH STERILIZERS

10.1. Precautions

When installing the device, follow the health and safety rules. Two people are needed to assemble the device.

10.2. Package contents

- pass-through sterilizer
- stand
- fastening bolts
- frame consisting of 4 elements
- frame installed in the device

10.3. Preparing the aperture in the wall

Before mounting, prepare the aperture with the dimensions given below:

For SRWP 115

Partition wall thickness: 50-100 mm
Aperture width: 715 mm
Aperture height: 990 mm
Height of the bottom edge of
the aperture relative to the ground: 530 mm

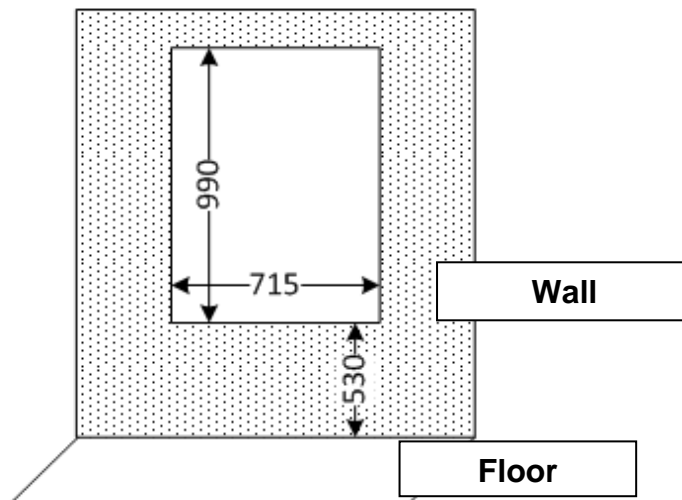

For SRWP 240

Partition wall thickness: 50-100 mm
Aperture width: 850 mm
Aperture height: 1250 mm
Height of the bottom edge of
the aperture relative to the ground: 270 mm

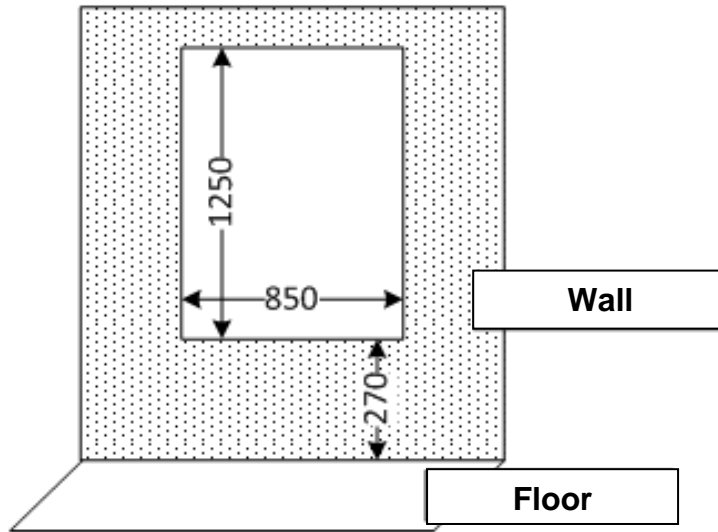

10.4. Installation of SRWP sterilizer

Fastening bolts

Screw in the 4 fixing bolts - tilt the device in such a way that you will be able to screw the fixing bolts into the special holes in the four corners of the bottom of the device. The device can be placed on screwed bolts.

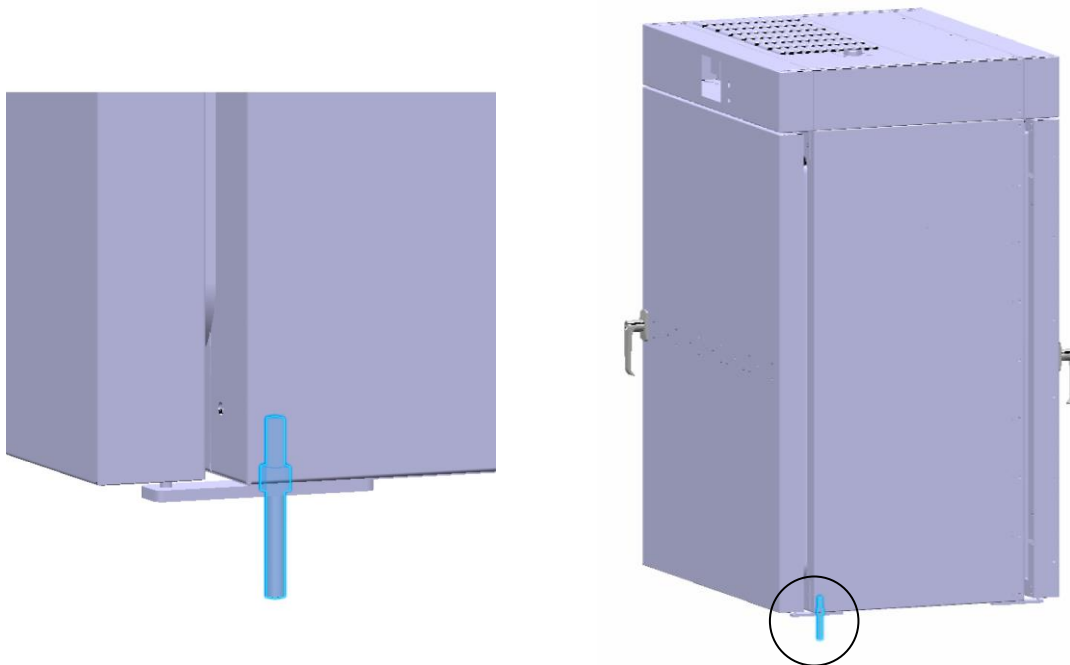

Stand installation

The device (1) should be placed on the stand (2) so that the fastening bolts hit the holes in the stand. After placing the device on the stand, tighten it with the nuts (3).

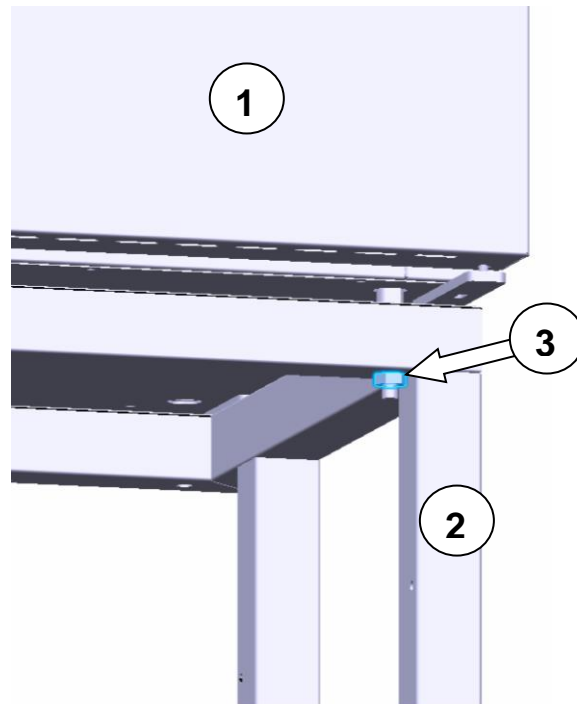

Placing the device in the aperture

Insert the device with the mounted stand into the aperture in the wall to such a depth that it will be possible to screw the frame on the opposite side.

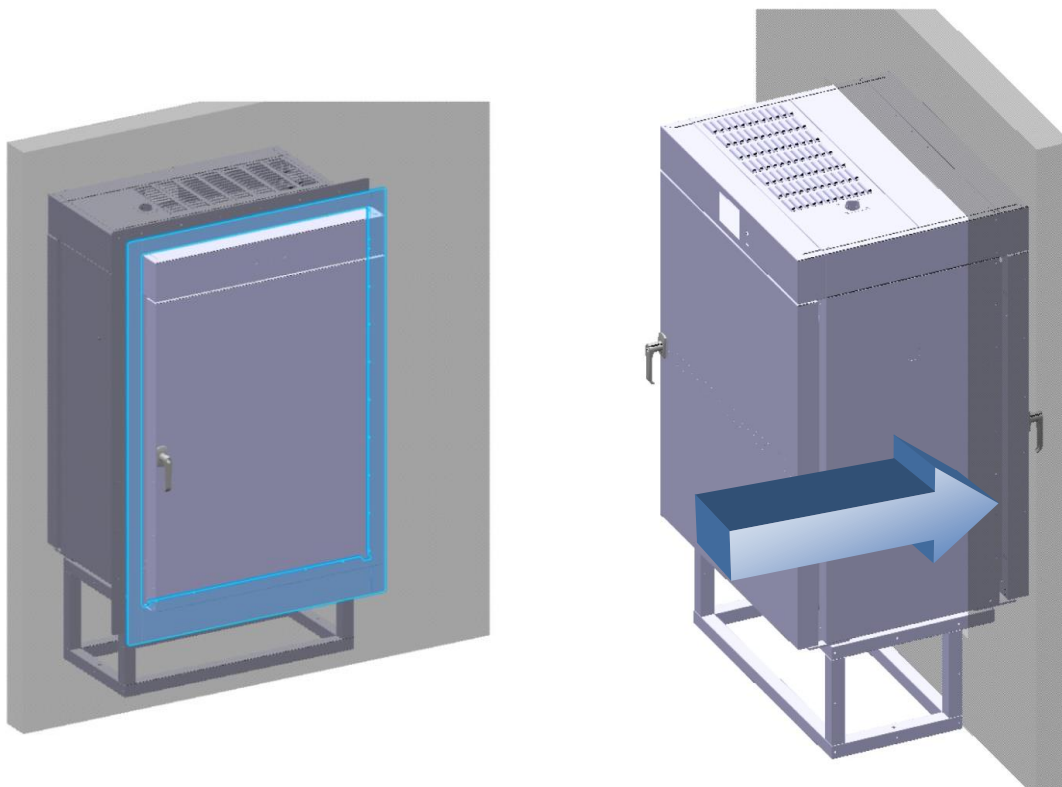

Frame and stand installation

To install the frame and the stand you need the following equipment (not supplied by the manufacturer):

- For masking element installation:
 - screws M4x8 (SRWP 115 -20 pcs.,SRWP 240 - 30 pcs.)
- for anchoring the stand depending on the surface.
 - chemical anchor + 2x threaded rod M8 length 120mm + 2x hex nut M10 DIN934 2x flat washer M10 DIN125 (recommended)
 - Wedge anchor M10x120 with washer and nut

Mount the frame with the screws. Then slide the device so that the frame rests against the wall. Tighten the frame to the wall with screws. Do the same on the opposite side.

Final work

The aperture can be sealed with acrylic sealant on both sides of the frame. Connect the power cord of the device to a power socket.

11. CONNECTING THE DEVICE TO A COMPUTER

Each device in the SMART version can be connected to an Ethernet network or directly to a computer with a LAN cable (optional). To read data (stored data and event log), you need the Lab Desk software (optional equipment). If you purchase the software, a LAN cable is included together with a hardware key, which should be inserted into the USB port of the computer. The installed Lab Desk software and hardware key allow reading the data stored in the internal memory of the device. The features of the software have been described in a separate instruction manual.

12. CLEANING AND MAINTENANCE OF THE DEVICE



Disconnect the device from the power supply before carrying out any activities related to the cleaning! In the case of the battery back-up of the controller, also turn it off.

On the internal walls of the device (in particular the new one) made of stainless steel, discoloration (spots) may appear - which are not caused by factory defects, but only by the steel production process. They can be cleaned using extraction gasoline.

INOX products are manufactured with stainless steel. When used in standard laboratory conditions they do not rust. However it is possible that stains (which may look like rust) form on the steel surface (e.g. due to the kind of samples that are incubated in the chamber). In such case we recommend using cleaning solution (to clean the stains) which is dedicated to this particular application, e.g. Pelox.



When cleaning stainless steel product with dedicated cleaning solution, one should pay attention to the suggestions and recommendations given in the instruction manual (or in the safety data sheet) of the cleaning solution.

12.1. Exterior cleaning

1.	The housing of the device should be cleaned at least once a week, depending on the working conditions.
2.	The housing and door should be cleaned with caution using a soft cloth dampened with water.
3.	Only mild cleaning products should be used to clean the device.
4.	Electrical parts should not get in contact with water or detergent.
5.	Clean the touch screen using a soft cloth or a foam for cleaning touch screens.
6.	USB port can be cleaned with a vacuum cleaner to prevent accumulation of dirt inside the port.

12.2. Interior cleaning

The interior of incubators, dryers and sterilizers is made of stainless steel 0H18 acc. with DIN 1.4301. Stainless steel 0H18 also corrodes, but much less and slower than other types of steel. To slow down the corrosion process as much as possible, this type of steel requires regular maintenance and cleaning. Avoid aggressive cleaning agents and preparations based on chlorine and bleach, do not allow stainless steel to come into contact with non-alloy steel, unless you are dealing with ground steel, and avoid materials that may scratch the surface.

1.	Before cleaning the interior of the device, empty the chamber.
2.	Open the door of the device, if necessary wait till the chamber has cooled down, take out the shelves and start cleaning of the device
3.	To clean the device, use a lint-free, lint-free, soft cloth and water or water with a mild detergent.
4.	In the case of ground steel, movements should be made in the direction of grinding on the surface.
5.	<p>If rust occurs:</p> <ul style="list-style-type: none"> - slight discoloration - use household cleaners for stainless steel containing calcium carbonate or citric acid, - medium discoloration - clean with a 10% phosphoric acid solution; after cleaning, neutralize the acid with diluted ammonia or a mild alkaline detergent, - severe rust - use products for pickling and passivation of steel - for example Pelox FR-D <p>After each cleaning, wipe the surface thoroughly with clean water.</p>
6.	Having finished cleaning, you should allow the device to dry fully and instal all parts removed before cleaning.
7.	During cleaning you should make sure not to damage the temperature sensors which are located inside the chamber.

12.3. Cleaning the touch screen

The touch screen is exposed to dirt, so it must be cleaned regularly. To clean the touch screen, use a clean and dry microfiber cloth. It is a very delicate material and collects dirt well.

	Before using the cloth, make sure that on the surface there are no crumbs or particles. During cleaning, they can act like sandpaper and scratch the surface of the screen.
---	--

If the stains cannot be removed by dry cleaning, the cloth can be lightly dampened with water.

	Do not use paper towels to clean the screen as it may cause microdamages.
---	--

Before cleaning, lock the screen by pressing  on the top drop-down list (Figure 59)

Figure 59 Locking the screen

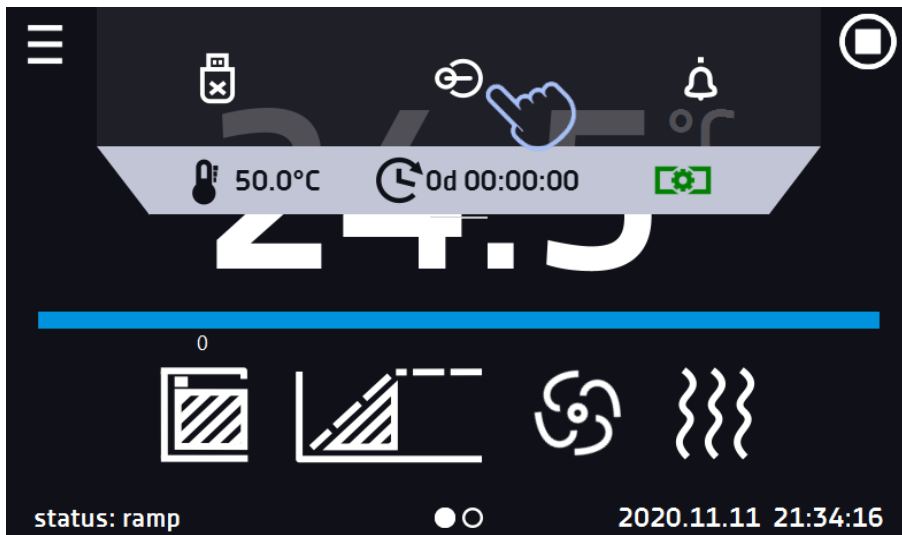

The screen is ready to be cleaned.

To unlock the touch screen, slide the blue circle into the white circle

Figure 60 Unlocking the screen

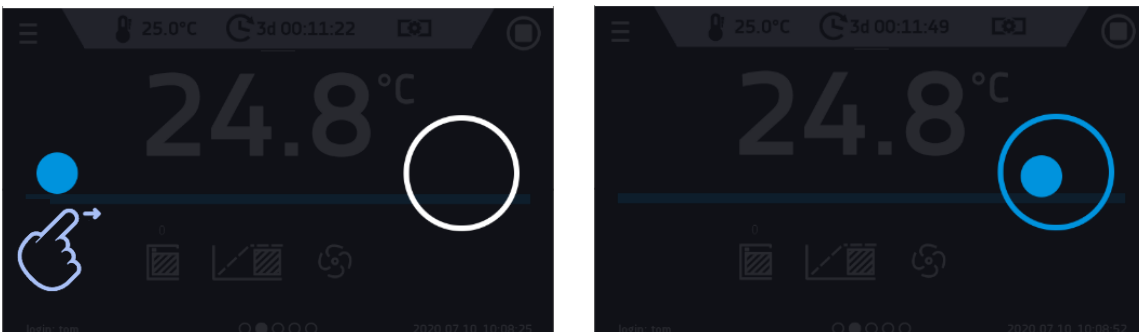

13. ADVICE ON HOW TO SAFELY STORE THE DEVICE

1.	Remove all objects from the chamber.
2.	Disconnect the device from the mains. If the unit is equipped with battery back-up of the controller (optional), also turn it off.
3.	Clean and dry the chamber.
4.	Leave the door open to avoid unpleasant odors.
5.	Store in temperatures between 0°C and 50°C and relative humidity maximum 70%.

14. TROUBLESHOOTING

Before you contact Service Department:

1.	Make sure that the operation complies with the instruction manual of the device.
2.	Restart the device to make sure that the unit is not functioning properly. If it still does not work, disconnect the unit again from the mains and repeat the operation after one hour. Do the same with optional battery back-up of the controller.

Service

Visit the POL-EKO website at: www.pol-eko.com.pl in order to:

- get full contact details of technical service
- access to POL-EKO online catalogue, and information about accessories and related products
- receive additional product information and special offers

To receive information or technical assistance, contact the Service Department or visit the website: www.pol-eko.com.pl

14.1. Possible defects

Malfunction	What to check?	What to do?
The unit is not working	Check if the unit is plugged in correctly	Plug in the unit correctly
	Check if the circuit-breaker has tripped	Press the circuit breaker on the back of the device
	Check the voltage in the socket	Connect the device to a different socket, preferably from a different electrical circuit. Call a licensed electrician to check the electrical installation.
	Check if the power cable is broken	Change the cable
The unit is not heating up	Check if the door of the unit is closed properly	Clean the gasket
	Check if the fan is turned on	Set the fan operation in the program
	Check if the ambient temperature is within the permissible values given in the technical data table?	Adjust the ambient temperature to the value given in this manual
The unit is working too loud	Check if the unit is not touching other objects or furniture etc.	Remove other objects
	Check if the door is properly leveled	Level the device
The door has dropped or is skewed	Check if the door is properly leveled	Level the device. If this does not help, contact the service.

15. WARRANTY CONDITIONS

POL-EKO warrants that this product will be free from defects in material and workmanship for a period of two (2) years from date of the invoice. If a defect is present, POL-EKO will, at its option and cost, repair, replace, or refund the purchase price of this product to the customer, provided it is returned during the warranty period. This warranty does not apply if the product has been damaged by accident, abuse, misuse, or misapplication, or from ordinary wear and tear. If the required maintenance and inspection services are not performed according to the manuals and any local regulations, such warranty turns invalid.

The device that is being returned must be secured by the customer in the event of any damage or loss. The warranty will be only limited to the situations listed above. IT IS EXPRESSLY AGREED THAT THIS WARRANTY WILL BE IN LIEU OF ALL WARRANTIES OF FITNESS AND IN LIEU OF THE WARRANTY OF MERCHANTABILITY.

All complaints should be reported using the form available on the website <http://www.pol-eko.com.pl/en/service>

Compliance with local laws and regulations

The user is responsible for obtaining any approvals or authorizations required to launch and use the product. POL-EKO shall not be liable for any negligence in the above matter except when the refusal to obtain authorization is caused by a product defect.

16. RATING PLATE

The rating plate is located on the left side wall in the upper left corner. Below there is an example of a rating plate:

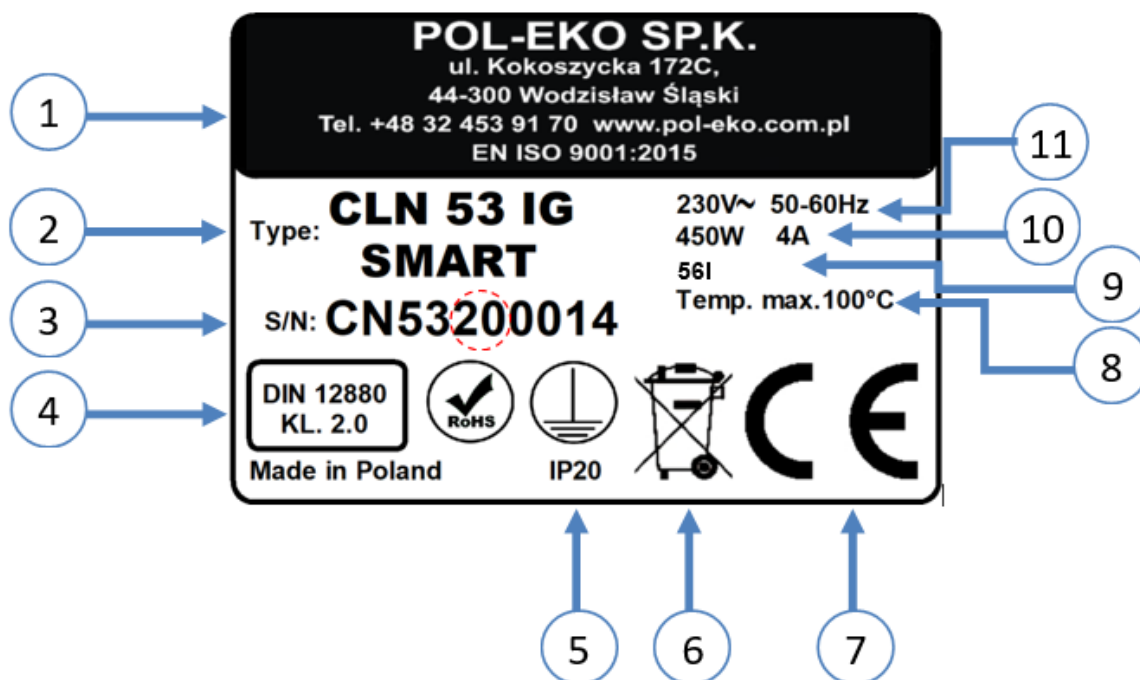

1. Manufacturer's data
2. Type of device
3. Serial number (the two marked digits indicate the year of manufacture of the device)
4. Temperature protection class according to DIN 12880
5. Degree of protection against electric shock (class I: protection against indirect contact) and IP enclosure protection rating
6. Disposal of used device according to WEEE2
7. CE marking as confirmation of compliance with the directives
8. Maximum temperature range of the device
9. Capacity of the device
10. Maximum power consumption
11. Acceptable range of voltage and frequency of mains supply

17. TECHNICAL DATA

Technical data are given with a tolerance of $\pm 5\%$, the working capacity of the chamber is always smaller. All the below technical data refers to standard units (without optional accessories).

17.1. CL, SL, SLWN*, SR, SRWP** devices

*SLWN – data as for SLW, **SRWP - data as for SRW 115 and SRW 240

Parameter	CL/SL 15	CL/SL 32	CL/SL/SR 53	SL75	CL/SL/SR 115	CL/SL180	CL/SL/SR 240	CL/SL/SR 400	CL/SL/SR 750	CL/SL/SR 1000	
Air convection	natural (N) / forced (W)							forced (W)			
Chamber capacity ¹ [l]	15	32	56	74	112	180	245	424	749	1005	
Door	solid		solid/with viewing window (option)								
Temperature range	CL	+5°C above ambient temperature...+100°C +41°F above ambient temperature ... 212°F									
Temperature range	SL	+5°C above ambient temperature ...+300°C +41°F above ambient temperature ...572°F									
Temperature range	SR	+5°C above ambient temperature ...+250°C +41°F above ambient temperature ...482°F									
Temperature resolution [°C]	every 0,1										
Controller	microprocessor with external touch screen										
Interior	acid-proof stainless steel according to DIN 1.4301										
Housing	-	powder coated sheet									
	INOX/G	stainless steel linen finish									
Overall dims ² [mm]	A width	510	590	590	590	650	650	810	1010	1260	1260
	B height	550	630	700	850	850	1030	1200	1430	1600	2000
	C depth	470	520	620	570	710	820	770	780	870	880
Internal dims [mm]	D width	320	400	400	400	460	470	600	800	1040	1040
	E height	230	320	390	530	540	720	800	1040	1200	1610
	F depth	200	250	360	350	450	560	510	510	600	600
Max shelf workload ⁵ [kg]	-	10	10	25	25	25	25	25	25	-	-
	version PW ³	-	-	50	50	50	50	100	100	100	100
Max unit workload [kg]	-	20	30	40	40	60	75	90	120	140	-
	version W ⁴	-	-	80	80	120	120	300	300	300	300
Nominal power [W]	consult rating plate of the device										
Weight [kg]	27	35	50	56	65	94	126	174	260	330	
Temp. protection	class 2.0 according to DIN 12880 / class 3.1 (option)										
Power supply	SL	230 [V] $\pm 10\%$ / 50 [Hz]						400 [V] $\pm 10\%$ / 50 [Hz] 3P+N+PE			
	SR	230 [V] $\pm 10\%$ / 50 [Hz]						400 [V] $\pm 10\%$ / 50 [Hz] 3P+N+PE			
	CL	230 [V] $\pm 10\%$ / 50 [Hz]									
Shelves fitted/max	1/2	1/3	2/5	2/5	2/7	3/9	3/10	3/14	5/16	6/22	
Warranty	24 months										
Manufacturer	POL-EKO										

1. working chamber is always smaller
2. depth does not include 50mm of power cable
3. reinforced shelf
4. reinforced version
5. on uniformly loaded surface

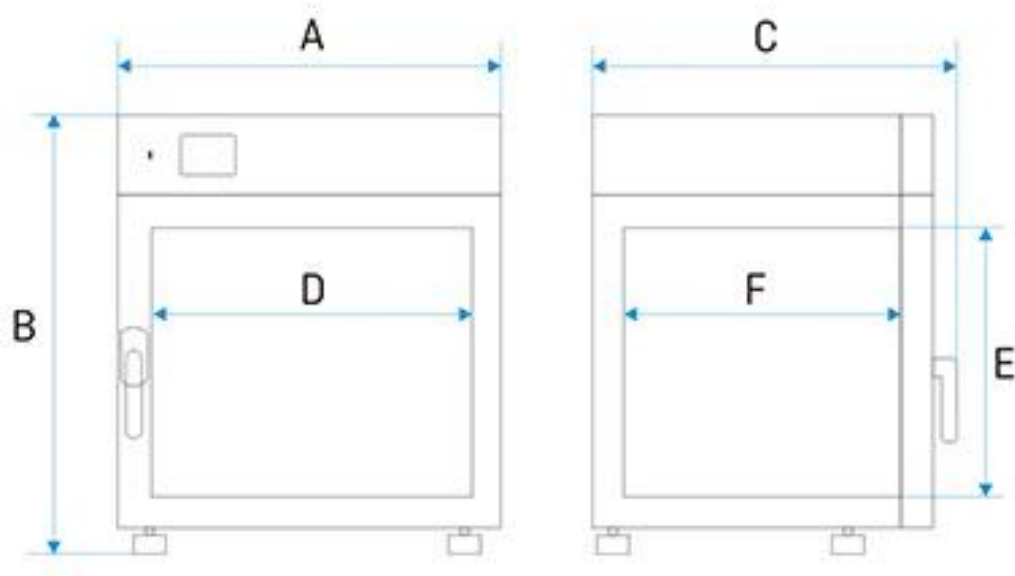

CL, SL, SLWN, SR, SRWP

18. DECLARATIONS OF CONFORMITY

 DEKLARACJA ZGODNOŚCI UE EU DECLARATION OF CONFORMITY		 POL-EKO
Produkt:	Product:	
Cieplarka laboratoryjna	Laboratory incubator	
Model:	Model:	
CLW 15; CLW 32; CLW 53; CLW 115; CLW 180; CLW 240; CLW 400; CLW 750; CLW 1000 CLN 15; CLN 32; CLN 53; CLN 115; CLN 180; CLN 240		
w wersjach:	in version:	
SMART; IG SMART; SMART PRO; IG SMART PRO		
Nazwa i adres producenta:	Name and address of the manufacturer:	
POL-EKO A.Polok-Kowalska sp.k. ul. Kokoszycka 172 C 44-300 Wodzisław Śląski Polska/Poland		
Niniejsza deklaracja zgodności wydana zostaje na wyłączną odpowiedzialność producenta.	This declaration of conformity is issued under the sole responsibility of the manufacturer.	
Wymieniony powyżej przedmiot niniejszej deklaracji jest zgodny z odnośnymi wymaganiami unijnego prawodawstwa harmonizacyjnego:	The object of the declaration described above is in conformity with the relevant Union harmonisation legislation:	
LVD 2014/35/UE EMC 2014/30/UE RoHS 2015/863 WEEE 2012/19/UE	LVD 2014/35/EU EMC 2014/30/EU RoHS 2015/863 WEEE 2012/19/EU	
Odniesienia do odnośnych norm zharmonizowanych, które zastosowano lub do innych specyfikacji technicznych, w stosunku, do których deklarowana jest zgodność:	References to the relevant harmonised standards used or references to the other technical specifications in relation to which conformity is declared:	
LVD	PN-EN 61010-1:2011 PN-EN 61010-2-010:2015-01 PN-EN 60529:2003/A2:2014-07	
EMC	PN-EN IEC 61326-1:2021-10	
RoHS	PN-EN IEC 63000:2019-01	
Wodzisław Śl. 02.01.2023		



DEKLARACJA ZGODNOŚCI UE
EU DECLARATION OF CONFORMITY



Produkt: Suszarka laboratoryjna	Product: Drying oven
Model: SLW 15; SLW 32; SLW 53; SLW 75; SLW 115; SLW 180; SLW 240; SLW 400; SLW 750; SLW 1000 SLN 15; SLN 32; SLN 53; SLN 75; SLN 115; SLN 180; SLN 240	Model:
w wersjach: SMART; IG SMART; SMART PRO; IG SMART PRO	in version:
Nazwa i adres producenta: POL-EKO A.Polok-Kowalska sp.k. ul. Kokoszycka 172 C 44-300 Wodzisław Śląski Polska/Poland	Name and address of the manufacturer:
Niniejsza deklaracja zgodności wydana zostaje na wyłączną odpowiedzialność producenta.	This declaration of conformity is issued under the sole responsibility of the manufacturer.
Wymieniony powyżej przedmiot niniejszej deklaracji jest zgodny z odnośnymi wymaganiami unijnego prawodawstwa harmonizacyjnego: LVD 2014/35/UE EMC 2014/30/UE RoHS 2015/863 WEEE 2012/19/UE	The object of the declaration described above is in conformity with the relevant Union harmonisation legislation: LVD 2014/35/EU EMC 2014/30/EU RoHS 2015/863 WEEE 2012/19/EU
Odniesienia do odnośnych norm zharmonizowanych, które zastosowano lub do innych specyfikacji technicznych, w stosunku do których deklarowana jest zgodność: LVD EMC RoHS	References to the relevant harmonised standards used or references to the other technical specifications in relation to which conformity is declared: PN-EN 61010-1:2011 PN-EN 61010-2-010:2015-01 PN-EN 60529:2003/A2:2014-07 PN-EN IEC 61326-1:2021-10 PN-EN IEC 63000:2019-01

Wodzisław Śl. 02.01.2023



DEKLARACJA ZGODNOŚCI UE
EU DECLARATION OF CONFORMITY



Produkt: Suszarka laboratoryjna z możliwością przedmuchiwania azotem	Product: Drying oven with nitrogen blow
Model: SLWN1 15; SLWN1 32; SLWN1 53; SLWN1 115; SLWN1 240; SLWN2 15; SLWN2 32; SLWN2 53; SLWN2 115; SLWN2 240.	Model:
w wersjach: SMART; IG SMART; SMART PRO; IG SMART PRO	in version:
Nazwa i adres producenta: POL-EKO A.Polok-Kowalska sp.k. ul. Kokoszycka 172 C 44-300 Wodzisław Śląski Polska/Poland	Name and address of the manufacturer:
Niniejsza deklaracja zgodności wydana zostaje na wyłączną odpowiedzialność producenta.	<i>This declaration of conformity is issued under the sole responsibility of the manufacturer.</i>
Wymieniony powyżej przedmiot niniejszej deklaracji jest zgodny z odnośnymi wymaganiami unijnego prawodawstwa harmonizacyjnego:	<i>The object of the declaration described above is in conformity with the relevant Union harmonisation legislation:</i>
LVD 2014/35/UE EMC 2014/30/UE RoHS 2015/863 WEEE 2012/19/UE	LVD 2014/35/EU EMC 2014/30/EU RoHS 2015/863 WEEE 2012/19/EU
Odniesienia do odnośnych norm zharmonizowanych, które zastosowano lub do innych specyfikacji technicznych, w stosunku, do których deklarowana jest zgodność:	<i>References to the relevant harmonised standards used or references to the other technical specifications in relation to which conformity is declared:</i>
LVD	PN-EN 61010-1:2011 PN-EN 61010-2-010:2015-01 PN-EN 60529:2003/A2:2014-07
EMC	PN-EN IEC 61326-1:2021-10
RoHS	PN-EN IEC 63000:2019-01

Wodzisław Śl. 02.01.2023

W imieniu producenta podpisał:

M. Hofarczyk
Małgorzata Szafarczyk
Dyrektor Generalny (CEO)



DEKLARACJA ZGODNOŚCI UE
EU DECLARATION OF CONFORMITY



Produkt: Steryliizator laboratoryjny	Product: Laboratory sterilizer
Model: SRW 53; SRW 115; SRW 240; SRW 400; SRW 750; SRW 1000 SRN 53; SRN 115; SRN 240	Model:
w wersjach: IG SMART; SMART	in version:
Nazwa i adres producenta: POL-EKO A.Polok-Kowalska sp.k. ul. Kokoszycka 172 C 44-300 Wodzisław Śląski Polska/Poland	Name and address of the manufacturer:
Niniejsza deklaracja zgodności wydana zostaje na wyłączną odpowiedzialność producenta.	This declaration of conformity is issued under the sole responsibility of the manufacturer.
Wymieniony powyżej przedmiot niniejszej deklaracji jest zgodny z odnośnymi wymaganiami unijnego prawodawstwa harmonizacyjnego: LVD 2014/35/UE EMC 2014/30/UE RoHS 2015/863 WEEE 2012/19/UE	The object of the declaration described above is in conformity with the relevant Union harmonisation legislation: LVD 2014/35/EU EMC 2014/30/EU RoHS 2015/863 WEEE 2012/19/EU
Odniesienia do odnośnych norm zharmonizowanych, które zastosowano lub do innych specyfikacji technicznych, w stosunku, do których deklarowana jest zgodność: LVD EMC RoHS	References to the relevant harmonised standards used or references to the other technical specifications in relation to which conformity is declared: PN-EN 61010-1:2011 PN-EN 61010-2-010:2015-01 PN-EN 60529:2003/A2:2014-07 PN-EN IEC 61326-1:2021-10 PN-EN IEC 63000:2019-01

Wodzisław Śl. 02.01.2023

W imieniu producenta podpisał:

Małgorzata Szafarczyk
Dyrektor Generalny (CEO)



DEKLARACJA ZGODNOŚCI UE
EU DECLARATION OF CONFORMITY



Produkt: Sterylicator przelotowy	Product: Pass-through sterilizer
Model: SRWP 115; SRWP 240;	Model:
w wersjach: IG SMART; SMART	in version:
Nazwa i adres producenta: POL-EKO A.Polok-Kowalska sp.k. ul. Kokoszycka 172 C 44-300 Wodzisław Śląski Polska/Poland	Name and address of the manufacturer:
Niniejsza deklaracja zgodności wydana zostaje na wyłączną odpowiedzialność producenta.	This declaration of conformity is issued under the sole responsibility of the manufacturer.
Wymieniony powyżej przedmiot niniejszej deklaracji jest zgodny z odnośnymi wymaganiami unijnego prawodawstwa harmonizacyjnego: LVD 2014/35/UE EMC 2014/30/UE RoHS 2015/863 WEEE 2012/19/UE	The object of the declaration described above is in conformity with the relevant Union harmonisation legislation: LVD 2014/35/EU EMC 2014/30/EU RoHS 2015/863 WEEE 2012/19/EU
Odniesienia do odnośnych norm zharmonizowanych, które zastosowano lub do innych specyfikacji technicznych, w stosunku, do których deklarowana jest zgodność:	References to the relevant harmonised standards used or references to the other technical specifications in relation to which conformity is declared:
LVD	PN-EN 61010-1:2011 PN-EN 61010-2-010:2015-01 PN-EN 60529:2003/A2:2014-07
EMC	PN-EN IEC 61326-1:2021-10
RoHS	PN-EN IEC 63000:2019-01

Wodzisław Śl. 02.01.2023

W imieniu producenta podpisał:

Małgorzata Szafarczyk
Dyrektor Generalny (CEO)

Instruction manual CL, SL, SLWN, SR, SRWP SMART

Manufacturer of control and measurement equipment
for laboratory tests and technological processes,
distributor in Poland of the following companies:
HAMILTON, NICKEL ELECTRO, RODWELL, THERMO SCIENTIFIC, WTW.

We produce:

- thermostatic cabinets
- laboratory refrigerators
- laboratory incubators
- devices with photoperiod and phytotron system
- drying ovens and sterilizers
- drying ovens with nitrogen blow
- laboratory freezers
- ultra-low freezers
- climatic chambers
- Caldera fluid and blanket warmers
- colony counters
- laboratory shakers
- stationary samplers
- Hydromat water dispensers
- Eurodrop stations
- FEKO+ waste water receipt station
- heating ovens
- cooled incubators
- fume hoods

We offer portable, laboratory and on-line equipment:

- pH-meters
- ionmeters
- dissolved oxygen meters
- conductivity meters
- photometers and spectrophotometers
- thermo reactors
- turbidity metres
- pH electrodes
- conductivity sensors
- oxygen probes
- heavy metals trace analyzers
- water baths
- autoclaves
- pH buffer solutions
- conductivity standards
- photometric tests
- laboratory accessories
- consumables

We organize:

- regional trainings
- individual trainings
- seminars

We provide:

- warranty and post-warranty service
- consultancy in the selection, maintenance and operation of laboratory equipment

POL-EKO LAB is Accredited by the Polish Centre for Accreditation (a member of ILAC) and provides accredited calibration of:

- thermostatic and climatic chambers (incubators, drying ovens, thermostatic cabinets, climatic chambers, freezers)
- water baths and thermo reactors
- autoclaves
- electric and electronic thermometers
- data loggers
- high temperature laboratory furnaces
- thermohygrometers
- laboratory sieves

Calibration is confirmed with the issue of 'Calibration Certificate'.

Services outside the scope of accreditation:

- checking equipment for physicochemical measurements (meters and probes),
- carrying out IQ, OQ, PQ qualification procedures,
- mapping of temperature and humidity in the rooms

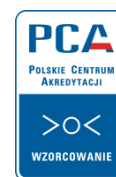

AP 115



☎ (+48) 32 453 91 70
✉ info@pol-eko.com.pl
🌐 www.pol-eko.com.pl

📍 **POL-EKO A. Polok - Kowalska sp.k.**
44-300 Wodzisław Śląski
ul. Kokoszycka 172 C